

**DESERT
EQUINOX**

2017

**SUN & EARTH, A PRELUDE TO A
BROKEN HILL BIENNALE OF ART**

**AGL Viewing Platform
Art & Design
Competition**

**EXHIBITION
CATALOGUE**

Broken Hill Art Exchange



Third Edition



AGL VIEWING PLATFORM NATIONAL ART & DESIGN COMPETITION

Desert Equinox 2017

Sun & Earth, a prelude to a Broken Hill Biennale of Art

Friday 17 March Exhibition

Doors open at 6pm with 6.30pm start

GeoCentre

Cnr Bromide and Crystal Street

Friday 24 March

Finalist Presentation

7pm Ivory Room Musicians club

Saturday 25 March

3pm Winners announcement Afternoon Tea

GeoCentre, cr. Crystal and Bromide Streets

THE AGL VIEWING PLATFORM ART & DESIGN COMPETITION

Together with the Broken Hill Art Exchange, AGL Energy Ltd ran an open-entry competition to create a design for a viewing platform to be built overlooking the solar farm site just outside Broken Hill, NSW.

With a \$10,000 cash prize to the winning entry, four incentive grants of \$1,000 to finalists, and a Peoples' Choice Award of \$1,000 the total prize pool of \$15,000 was donated by AGL Energy Ltd.



The Broken Hill Solar Plant

In conjunction with the Australian Renewable Energy Agency (ARENA) and the NSW Government, AGL delivered two large-scale solar photovoltaic (PV) power plants with a total capacity of 155 MW (AC) at Nyngan (102 MW) and Broken Hill (53 MW) in regional New South Wales. The Broken Hill Solar Plant is expected to generate approximately 126,000 megawatt hours (MWh) of clean, renewable electricity each year.



The site is located approximately five kilometres southwest of the Broken Hill township, adjacent to Willyama Common. The solar plant occupies approximately 140 hectares of land bounded by the Barrier Highway to the north and the Peterborough-Broken Hill rail line to the south.

One of Australia's largest utility-scale solar PV power plants, situated in Mad Max country far-west NSW, the site is embraced by the spectacular beauty of the outback, an extraordinary melding of sustainable-energy ideology with the sun-scorched agelessness of Australia.

The Broken Hill Art Exchange

Broken Hill Art Exchange is a not-for-profit organisation dedicated to building the creative industries of the city of Broken Hill and the Western region of New South Wales, Australia. Our grass roots organisation offers a whole-of-community approach to art and community cultural development.

Providing live-in residencies, exhibition and workshop spaces, consultancy services, events and project management, the Art Exchange is a trans-disciplinary organisation facilitating the arts and other sectors. The residency provides private live-in studio apartments and self-contained rooms with access to communal spaces.



Residents can pursue their practices, participate in community activities, conduct workshops, and create opportunities to share and further their skills, knowledge and expertise. Applications for residency and other opportunities are accepted throughout the year.

BROKEN HILL ART EXCHANGE

Gary Cook

Honorary President

Broken Hill is, as we are all aware, blessed with bountiful sunshine. It therefore makes perfect sense for the energy of the Sun, the ultimate source of energy for all life on Earth, to be harnessed for use by our local communities. AGL has demonstrated initiative and innovation in establishing a Solar Plant in the Broken Hill area.

Broken Hill has also been blessed with a vigorous and dynamic creative community. Despite the tyranny of distance, we continue to have a community of artists of various media that have gained national and even international recognition. The Broken Hill Art Exchange (BHAЕ) has as its core purpose the encouragement of all those engaged in creative pursuits in the local area and beyond.

It is therefore a happy partnership that has been formed between AGL and BHAЕ to produce a design for a platform to view a state of the art renewable and sustainable energy production plant located near Australia’s first heritage-listed city. It is anticipated that the outcome of this partnership will lead to an iconic structure that will attract both locals and visitors to our region.

The competition itself has attracted over 100 entries from as far afield as Finland and Singapore. I’m also happy to say that there have been a significant number of local submissions. Thanks to all who have entered the competition. The task of selecting an ultimate winner has been a demanding one for our panel of judges and we are most grateful to them for undertaking this role. Our gratitude must also be extended to Susan Thomas and Armando Licul for the many hours they have spent in co-ordinating this competition. Finally I would like to express our deep appreciation to AGL for both investing in and engaging with our local community both through establishing the Solar Plant and building what promises to be an outstanding platform from which to view it.

Susan Thomas

Artistic Director

The theme of this first event for Broken Hill Art Exchange 2017 Desert Equinox is ‘Sun & Earth’. This National AGL Art & Design competition, to design a viewing platform at the Broken Hill Solar Plant makes an iconic statement. It has enabled people from all walks of life to champion sustainable environmental practices and attracted participation by groups and individuals of varying ages, from amateurs to professionals across different fields of knowledge. Over one hundred people are participating in the competition, which collectively expresses the ingenuity, imagination and expertise of people with a genuine passion for a sustainable future. The exhibition of entries celebrates solar energy and the city of Broken Hill’s assets; its golden light and heritage of reform. The Solar plant in Broken Hill responds to the energy needs of 21st century and reframes Broken Hill’s legacy of 130 years of continuous mining to “mining the sun”. Broken Hill is located in the arid desert region of Far West New South Wales and it is Australia’s first and only heritage city. Its natural and built environments, climate, formidable landscape and heritage, ultimately necessitate innovative best practices in renewable energies, art and design, architecture and environmental management.





The Broken Hill Art Exchange is a grassroots art organisation and our methodology of interventionist *action research* builds local capacity in the creative industries to support the growth of art and artists. We recognise a responsibility to developing art in Australia by grasping Broken Hill's tradition of social, cultural and environmental change. Our concept of exchange reflects the abstract labyrinthine global networks of our era while grounding it spatially to the geographical experience and essence of 'place'. In March 2016, the Broken Hill Art Exchange initiated its Desert Equinox Preludes towards the establishment of a Broken Hill Biennale of Art through its Transdisciplinary Residential Program.

Our Desert Equinox prelude events contrast and unify the elemental subjects of Sun, Earth, Air and Water in context to the socio-economic, built and natural environments of Broken Hill. At our residency, we facilitate people interested in co - collaborative project development and expand interdisciplinary approaches to the exchange of knowledge, skills, and information through public events; workshops, guest speakers, exhibitions and special projects. We take this opportunity to thank the hundreds of people who have travelled with us along our fifteen-year exploratory journey.

The AGL Art & Design competition, is a collaborative project, between AGL Energy Limited and the Broken Hill Art Exchange and the reason for this exhilarating exhibition. As a true partnership, and a joint venture to achieving common goals it is perhaps one of the finest examples of positive reciprocity. In this sense our overlapping sociocultural interests demonstrate the value of corporate citizenship in ways that radiate, legitimise and leverage outcomes for the common good.

The Broken Hill Art Exchange acknowledges the Wiljakali People of the Barkindji Nation and Aboriginal elders past, present and future.



THE JUDGING PANEL

Darriea Turley, Mayor of Broken Hill

Mayor Darriea Turley has worked and volunteered in health and welfare for over 35 years. Darriea has been involved with and initiated various groups including: Chair of the National Rural Women's Coalition and Australian Local Government Women's Association, Vice Chair State Records NSW and is currently a Rural Director for the Local Government NSW. Cr Turley was also the former Chair of the Broken Hill Regional Art Gallery for over 20 years.

Darriea has served as a Broken Hill City Councillor since 1995 and was elected Mayor in 2016. In 2008 Cr Turley was nominated as New South Wales Woman of the Year and named Broken Hill Executive Woman of the Year.



In 2012 Cr Turley was appointed by the Commonwealth Government to the Australian delegation to the United Nations for the CSW 56. Cr Turley was awarded the 2012 NSW Local Government Award and Life Membership of the Australian Local Government Women's Association for her contribution to Local Government. In 2016 she was awarded the Edna Ryan Award. Darriea Turley leads in promoting the role of women in local government and the well-being of women in rural Australia.

Tony Chappel, Head of Government & Community Relations at AGL Energy Limited

As the Head of Government and Community Relations at AGL Energy Limited, Tony Chappel is accountable for delivering Government and Community engagement across AGL business units nationally.

Prior to joining AGL, Tony served as a Chief of Staff in the Baird Government, which he joined in 2012. Prior to that, Tony worked as a researcher at the Smith School for Enterprise and the Environment at the University of Oxford, where he worked on projects mapping sectoral sustainable development pathways for the government of Rwanda, and on applied research with AFD, the French development agency, regarding the use of economic tools to address environmental issues.



Tony Chappel and Karyn Looby, Manager Government and Community Relations.

In 2009, he left Australia to study energy policy on a Chevening Scholarship at Imperial College London and the University of Oxford, having worked in finance and equity capital markets since 2004 in the clean tech and resources sectors.

Dr Atanas Djonov

Dr ATANAS DJONOV is an artist and a PhD graduate who over several years of independent and collaborative art and curatorial practice, diverse teaching experience and research has developed and demonstrated strong interest, knowledge and ability to engage critically in art and curatorial practice, academic teaching and research in the areas of new media and video art, sound design, animation, installation and electronic art, analogue and digital photography and multimodal communication.

Timo Mantyvirta, Civil Engineer at AGL Energy Limited

Timo Mantyvirta is a Civil Engineer with over 30 years' experience in the electricity industry. Timo started with the SECV in the Melbourne head office as a structural engineer in 1980 and is currently providing civil engineering advice to AGL Hydro based in Mt Beauty. He was the site engineer during the construction of the Banimboola Power Station on the Dartmouth Power Station's Regulating Dam during 2003 to 2006 and then held a similar role during the construction of the Bogong Power Station from 2006 to 2009. He will be able to call upon his civil and structural experience to provide comments on the suitability and constructability of the options put forward as part of the competition for the Broken Hill solar plant viewing platform.





AGL Energy would like to congratulate the finalists of the **AGL viewing Platform Art and Design Competition**.

We also acknowledge the efforts of all of the entrants and thank you for your contribution.

The Viewing Platform Art and Design Competition was launched earlier this year to celebrate the opening of AGL's Broken Hill Solar Plant, a 140 hectare solar plant producing enough renewable energy to power 17,000 homes every year.

AGL also sincerely thanks the Broken Hill Art Exchange who joined AGL in sponsoring this Award.

We're committed to partnering with the communities in which we operate and this Award is one way we're delivering on that promise.

Energy in
action.®

Since 1837

AGL

For more information visit [agl.com.au/brokenhill](https://www.agl.com.au/brokenhill)



CATALOGUE OF ENTRIES



**CONSTRUCTION MATERIALS**

This proposal would use recycled timbers to retain the concept of renewable sources. The art should reflect the underlying initiative of the power plant. The tower would be placed on a concrete footing to establish a solid structure to endure the elements

DESCRIPTION: I propose to construct a downscaled observation Tower within and for the Broken Hill solar plant. The Tower is an essential continuation of my current arts practice, where I have previously developed and visualised the structure in simulation, drawings, animation, 3D printed form and has also been interpreted by a displaced community in Indonesia (See here for information: <http://www.simonfinn.info/html/SingleWorksHTML/Simon20Finn20BirthFromDestruction.html>). The Tower is not based on any particular tower; however, it is inspired from fire/tsunami look out towers, prison watchtowers, and metaphors of the observer/ed. It is symbolic of future prediction, and if is located close to the solar plant, its meaning would be one of optimism. This is especially pertinent symbol for viewing the environmental initiatives undertaken by Australian business for renewable energies.

The Panopticon (previously seen with negative connotations) is a pertinent symbol for our navigation within the current political climate, including media, propaganda and the control of our ability to see into the impending state of the natural order. Seeing the farsighted, and looking beyond the now, especially symbolic of seeing the investment in our countries' future through renewable energy. The tower would be approximately 1 meters high constructed using recycled wood to continue the theme of renewable source. If constructed, the Tower would be highly visible during the day and illuminated from within during the night (Maybe with the possibility of the light source powered from the solar panels). My artwork would offer an important message of potential optimism in a climate of environmental negativity.

BIOGRAPHY: Simon's practice includes, drawing, animation and sculpture and forms a continued exploration into the variable syntheses between artist, environment and technology. Finn utilises the spatial and temporal capabilities of virtual representations as subject matter that comes into being somewhere between experimental verification and poetic speculation. The range of static imagery generated through computation is staged and then re-imagined with the hand, using traditional drawing processes, and advanced machinery. This process allows Finn to observe an otherwise unattainable rupturing of time and facilitate a faceted network of production. Simon has presented twelve solo exhibitions since 2011, including 'Deluge Rotations' at Fehily Contemporary and 'Beyond the Frustum' at LUMA and the VAC in 2016. Group exhibitions in 2015 include 'New Dimensions' at Hill-Smith Gallery, 'Specific Gravity' at MOANA and 'Synthetica' (NETS) at Wangaratta Art Gallery, Swan Hill Regional Art Gallery, Gippsland Art Gallery, Wagga Wagga Art Gallery. Simon was a finalist in the Hazelhurst Regional Gallery Art on Paper Award (2015), City of Hobart Art Prize (2015) and the winner of the 2015 Banyule Award for works on paper. In 2014 his work was included in 'Vertigo' (Asialink), shown at Galeri Soemardja, Bandung

Institute of Technology Indonesia, MoCA in Taiwan and the POSCO Museum of Art, South Korea. 'Perceptions of Space' at the Glen Eira City Council and Surge, Plymouth College of Art, England. He has also been awarded the Howard Arkley Award, Kedumba Drawing Award, Athenaeum Award and the Stuart Black Travelling Scholarship. Finn's studies include, Master of Fine Art by research at the Victorian College of the Arts, First Class Honors in Fine Art from the Royal Melbourne Institute of Technology and Electronic Design and

Interactive Media at Swinburne University. His practice is supported by accumulated experience as a 3D visualisation artist, digital imagist, video editor, composer and animator for a range of international and local clientele. Simon is currently lecturing at the Royal Melbourne Institute of Technology in Specialised Communication in the School of Architecture (3D design and rapid prototyping).

2

ENTER THE SUN SEAN DIAMOND

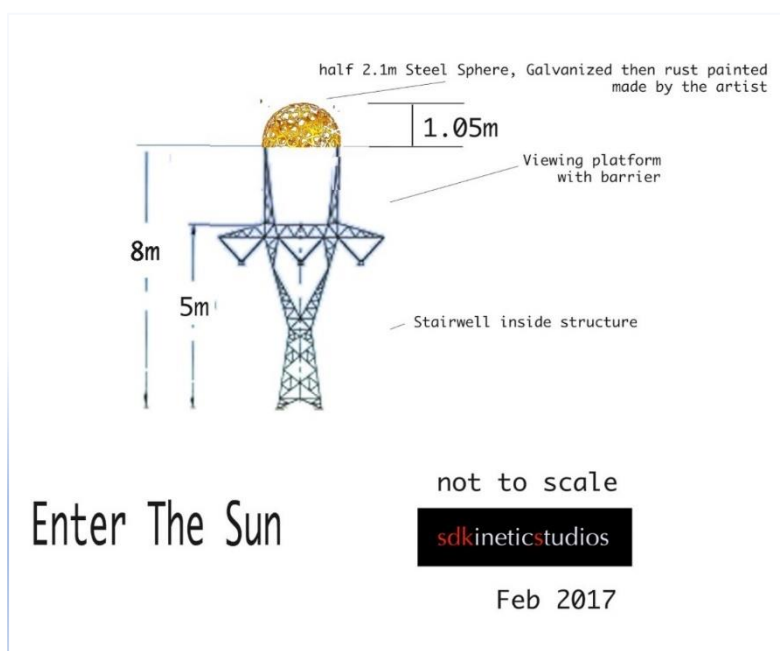

CONSTRUCTION MATERIALS

Constructed from reclaimed heavy industrial steel. The platform is constructed in the same materials and as a smaller version of high voltage transmission lines — hot dip galvanized steel to AS4680. The stairs are internal, welded steel, galvanized, non-slip. Half a steel sphere made from reclaimed heavy industrial steel, hot dip galvanized then painted with Rust Paint Platform floor; oil rig type flooring, see through.

DESCRIPTION

Half a steel sphere that takes on the colour of the sunset/sunrise. The half sphere sits atop (above head height) a 5m viewing platform. The platform is a small version of high voltage transmission lines. The stairs are internal.

BIOGRAPHY

Early career artist, reforming discarded materials into beautiful objects. I have performed at many public events including twice at White Night Melbourne with Spheres and dragons breathing fire. I have been working with steel for 30 years.



DESCRIPTION: My proposal is for an inclusive experience. I have tried to incorporate technology as well as art into one experience. It should be seen as a journey not just a view from a platform. The journey starts at a formalised parking area. There will be a transitional zone between the parking and the viewing platform; this will consist of an interactive garden. The garden will give the visitor options as to how they will approach the platform. The garden will have hard paved areas and soft areas consisting of selected shrub bush and grasses. The visitor can make the experience their own. The local arts community can use the garden to exhibit sculpture enhancing the visitor's experience. Once the visitor has transitioned the garden the second part of the journey begins. Instead of the traditional staircase leading to a platform, there will be a two-part ramp leading to the platform. This is to give paraplegics and the elderly the ability to experience the view from above. The first part of the climb is on a paved path up a plinth on which the platform sits. The second part of the climb will be up a timber walkway fixed to a steel supporting structure. The ramp will give the visitor an elevated view over the garden. The viewing platform will have 3 use areas a space for artists to exhibit their works, the open viewing platform and a space where the science of harvesting energy from the sun can be exhibited to the public through audio visual and hands on exhibits.

CONSTRUCTION MATERIALS: The platform will be constructed from two recycled shipping containers fixed to an off shutter concrete pier. Steel brackets fixed to the piers will hold the container in place. The concrete pier will protrude out of a rock plinth that acts as a ramp for access to the platform. All construction and insulation of the structure will be in accordance with the national Construction code. The power requirements for the structure will be via photovoltaic panels on the roof of the containers. The garden materials and structure are to be sourced locally where possible and from recycled materials wherever possible. All the balustrading will be glass so as not to interfere with the view from the platform and the ramp.

David Hamilton
043 456 5401
david.hamilton5336@gmail.com

THE AGL VIEWING PLATFORM ART & DESIGN COMPETITION



Broken Hill
Art Exchange



AGL
Energy in
action.

CONSTRUCTION MATERIALS: The platform will be constructed from two recycled shipping containers fixed to an off shutter concrete pier. Steel brackets fixed to the piers will hold the container in place. The concrete pier will protrude out of a rock plinth that acts as a ramp for access to the platform. All construction and insulation of the structure will be in accordance with the national Construction code. The power requirements for the structure will be via photovoltaic panels on the roof of the containers. The garden materials and structure are to be sourced locally where possible and from recycled materials wherever possible.

DESCRIPTION: I have tried to incorporate technology as well as art into one experience. It should be seen as a journey not just a view from a platform. The journey starts at a formalised parking area. There will be a transitional zone between the parking and the viewing platform; this will consist of an interactive garden. The garden will give the visitor options as to how they will approach the platform. The garden will have hard paved areas and soft areas consisting of selected shrub bush and grasses. The visitor can make the experience their own. The local arts community can use the garden to exhibit sculpture enhancing the visitor's experience. Once the visitor has transitioned the garden the second part of the journey begins. Instead of the traditional staircase leading to a platform, there will be a two-part ramp leading to the platform. This is to give paraplegics and the elderly the ability to experience the view from above. The first part of the climb is on a paved path up a plinth on which the platform sits. The second part of the climb will be up a timber walkway fixed to a steel supporting structure. The viewing platform will have 3 use areas a space for artists to exhibit their works, the open viewing platform and a space where the science of harvesting energy from the sun can be exhibited to the public through audio visual and hands on exhibits.

BIOGRAPHY: I have recently emigrated from South Africa where I had my own architectural practice. Unfortunately, the Australian authorities do not recognise my qualifications and as a result I am now unemployed until such time as I can get up to speed with the local requirements.

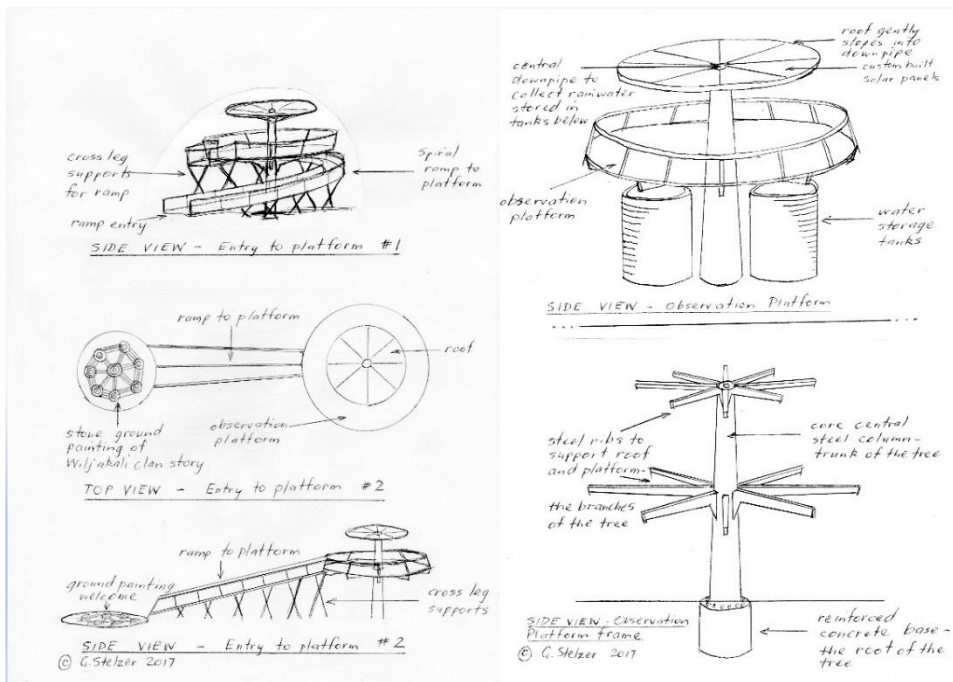
**CONSTRUCTION MATERIALS:**

To withstand the, at times, severe meteorological elements of the Broken Hill area and to provide strength to support the structure, it should be constructed of galvanized steel with its manufacture by local Broken Hill companies.

DESCRIPTION: Inspired by the timeless ground painting art of Aboriginal Australians and, in particular, to pay respect to the people and land of the local Wiljakali clan, my viewing platform design recreates the symbolic concentric rings of an

Aboriginal campsite, water hole or meeting place as seen from above. The smaller ring forms the roof which is clad in custom built solar panels gently sloping into the top of a central hollow steel post (tree trunk). The post not only provides the core strength of the structure, but its hollow core is used to drain rainwater collected on the roof into storage tanks below.

The larger ring provides a 360-degree viewing platform with visitor information, including information about the Wiljakali clan, presented on laser etched steel displays which are attached to the central post. Beneath the viewing platform, 8 tank structures provide water storage, compost toilet facilities and a kiosk. The tree-like engineered structure would be constructed of galvanised steel with a core post (trunk) and two sets of eight radiating ribs (branches) to support the roof and platform. The post would be secured with a reinforced concrete base (tree root). The structure would be manufactured in Broken Hill to specification.

Access to the viewing platform can be by either, a spiral steel ramp, which, when seen from above, adds an outer ring to the meeting place symbol or, a straight steel ramp connecting a large welcome Wiljakali ground painting symbolising the Aboriginal journey between water holes and camp sites. The work is presented as hand drawn sketches. The design has been inspired by the traditional Aboriginal ground painting art of Central Australia with architectural influences from the Sydney Airport Control Tower and the Brickpit Ring at the Sydney Olympic precinct.

BIOGRAPHY: I am a retired primary school principal who has held a lifelong interest in Art, Architecture and traditional Aboriginal culture. The opportunity to present my design brings together three of my passions. I am also a strong devotee of sustainable energy production having installed 4 Kws capacity solar panels on my house two years ago. I would love to see our country quickly transition to sustainable energy supply. As I write this biography, I am in Sydney with sustained extreme temperatures of 40+ degrees (currently 43 degrees in Broken Hill). The continued large scale burning of fossil fuel is leading our planet to cataclysmic climatic events.

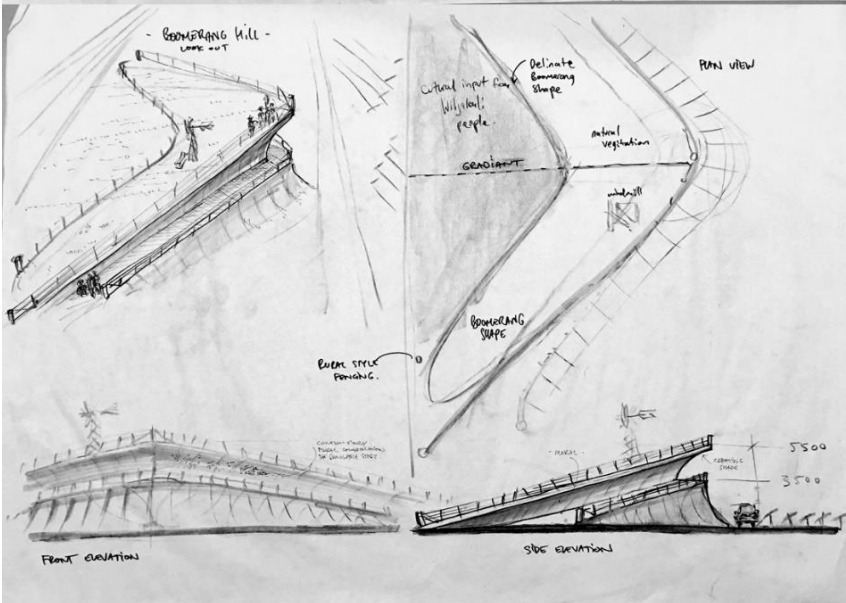

CONSTRUCTION MATERIALS

Rammed earth or concrete, natural earth/ paddock and rural materials. We want to pay homage to the local Aboriginal People, the Rural People who have settled since, we would also be trying to use colours representing silver, lead and zinc to include the miners with the Aboriginal art combined with the contemporary art to tell the story of going full circle ... from sun to sun ... back to renewable energy ... back to looking after Earth Mother back to looking after each other... as desert people do.

DESCRIPTION: Design sketches and Renderings. A simple concept of an earth mound in the shape of a boomerang with the two ends resting on the ground and the middle raised to create a viewing area. A man-made overhang will create a second tier viewing ramp offering shade and a mural surface to tell the renewable story of Broken Hill.

BIOGRAPHY: I'm an Artist, International Muralist, Designer, Architectural Draftsperson, Architectural Illustrator and have a deep and imbibing passion for Australia and the Bush and anything renewable. Let's work together to make Broken Hill, Australia and the world a better place.

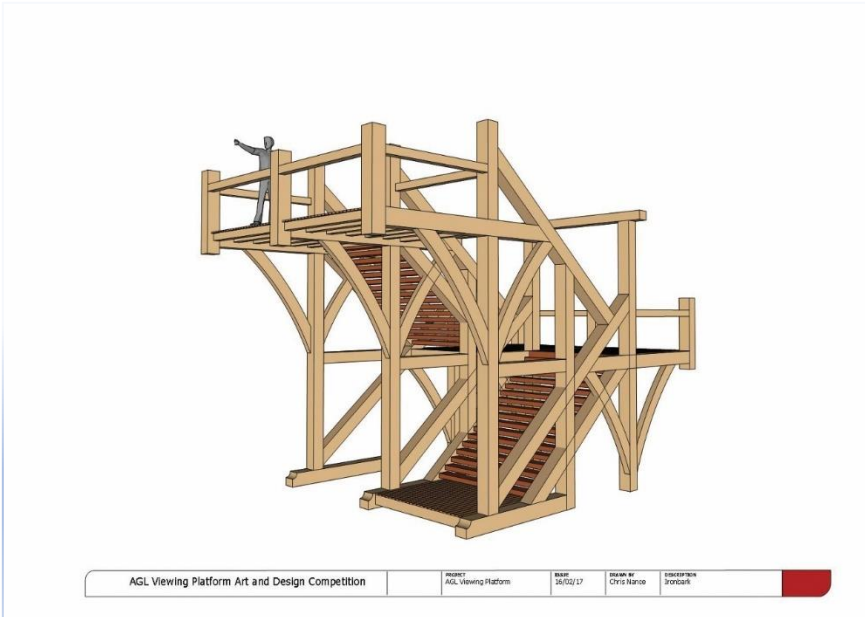

CONSTRUCTION MATERIALS

The design would be built entirely of sustainable sourced hardwood, including all connections, bracing and joinery detailing. Using timber for this structure has several benefits. Timber, grown in the forest, absorbs carbon from the atmosphere and would then lock away for the life of this structure. Timber from proper sources is the only sustainable construction material available making it the obvious choice. The timeless aesthetic appeal of timber would make this structure something to be admired for its beauty also. By using traditional timber joinery connections, this entire structure could be built of site, and installed on site at Broken Hill in a very short timeframe which would have several construction benefits.

DESCRIPTION: This viewing platform is a heavy timber structure, designed to reflect on the connection between history and endurance of the natural environment, the complexity of modern design and craftsmanship and the future drive and increased aspiration for a sustainable world. This design, involves the use of a large section of hardwood timbers joined together with traditional timber joinery to form a large open stairway up to 6m high viewing platform.

BIOGRAPHY: I am a woodworker with experience in the design and construction of traditional timber structure. Having trained as a carpenter and builder in both the Southern Highlands of New South Wales in the UK working on historical and traditional buildings, I have developed several skills in this field. For the past seven years, I have run a specialist woodworking business that builds and teaches traditional timber construction and woodwork across Australia

Platform Broken Hill Solar AGL



Outside viewing platform is around the rim with of course a glass safety fence. The front of the hat is a glass window for inside viewing. The lamp is powered by solar panels mounted down the centre of the hat

The entrance is spiral stairs with a wheelchair lift in the centre.

Displays could be placed in and around the miners Lamp suggested displays could be solar power information, the history of light and the Aboriginal dreamtime associated with the Pinnacles.

CONSTRUCTION MATERIALS

Steel frame, fibreglass for miner's hat and glass windows and fence.

DESCRIPTION: The viewing platform for the Solar farm would be impressive made in the shape of a miner's hard hat. It would be raised and supported in the middle where the stairs would be arranged around a small wheelchair lift. The front of the hat would have windows for indoor viewing and the rim could be used as an outdoor viewing platform area having a glass safety fence placed around the rim. Around the bottom could be the information of the solar farm. Some suggestions for inside the hat could be the history of light and Aborigines dreamtime history of the Pinnacles which could be seen in the distance. The lamp could be lit be solar panels mounted on top down the middle of the hardhat

BIOGRAPHY

I was born and bred in Broken Hill and at the moment working at Essential Water as an Electrical Technical Officer.

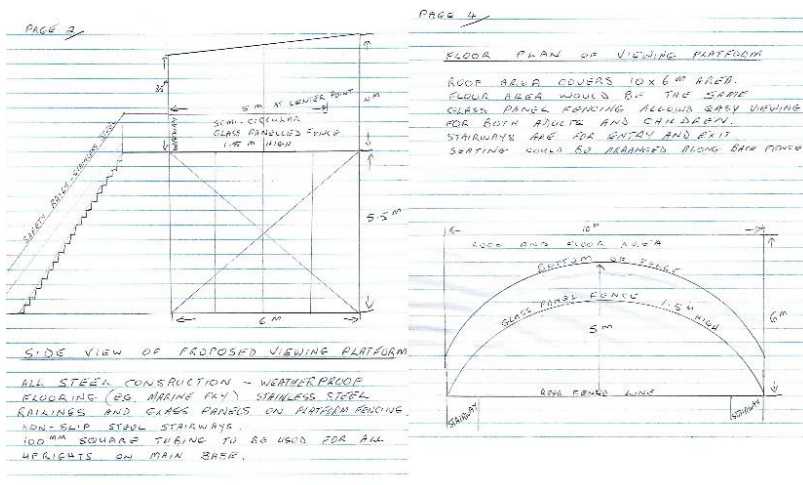

CONSTRUCTION MATERIALS

Steel framework, weatherproof flooring. Much stronger construction, galvanized steel, non-rusting.

BIOGRAPHY

I am a 76-year-old, retired mine supervisor and capable handyman

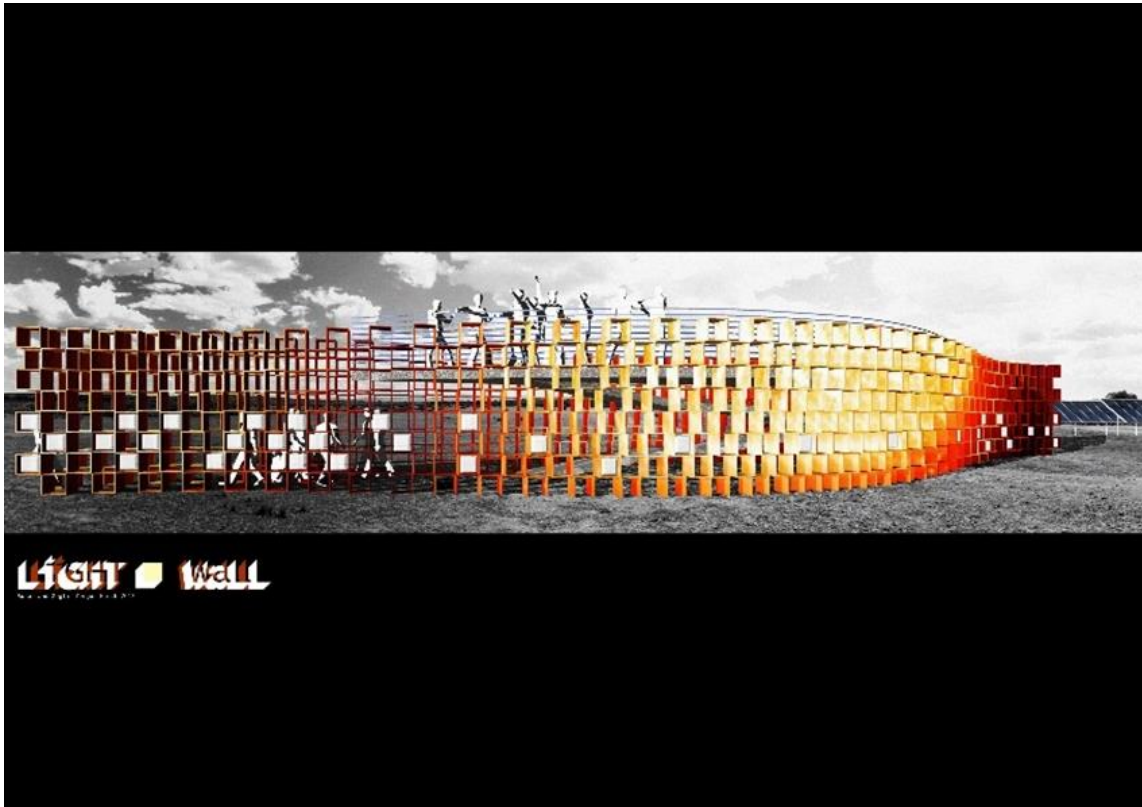

CONSTRUCTION & MATERIALS: Cube bricks: prefabricated metal cubes, 450 x 450 x 450mm, computer control manufacture (CNC), folded open ended boxes, bracket assembled on site; Platform and ramps: suspended geopolymer concrete viewing platform and ramps, using slag/fly ash based geopolymer concrete (trademark: Earth Friendly Concrete or EFC); Project management: 3D building information model (BIM) controlling brick pattern management, specifying orientation, location and placement of each cube; Solar Image: digital printed solar chromosphere/ transition region image (similar to AIA 304 Å 50,000 kelvin, light emitted from the chromosphere/ transition region). Solar Image: digital printed solar chromosphere/ transition region image (similar to AIA 304 Å 50,000 kelvin, light emitted from the chromosphere/ transition region).

DESCRIPTION: LiGHT-WaLL Fluidic experience of light by using carefully arranged perforated walls, shelter from hot desert climate, and elevated views of the solar field. Visitors enter at either end between parallel undulating 'brick pattern' walls. The walls are constructed using computer arranged stacked open cube bricks. Moving between these walls and up the access ramp visitors pass information signage 'light-boxes' explaining the solar project and installation. Moving between the walls visitors will experience continuously varying vistas and changes to light quality and quantity. The viewing platform over will create ground level shade and shelter, perforated walls allow air to circulate. The visitor's experience changes at the elevated viewing platform with 360° views of the solar field and surrounding landscape. LiGHT-WaLL affords elevated views over the solar field accessed by a code compliant ramp. At entry level, it provides a sheltered breezeway and seating for viewing information panels. The undulating cube brick wall will create a variable interplay between views/ vistas and light/ shadow which together with the solar chromosphere image will remind visitors of the fundamental role of sunlight for this project.

In early 2016 Sue and Zeglar downsized, converted a VF Commodore ute into a retro-Sandman panel van and started travelling. From an interest in architecture, exploring and drawing we developed the DrawPerson blog site where we record the unique buildings and forms of Australia. We have exhibited drawings in Brisbane, Melbourne and many regional galleries as well as conducted drawing workshops.

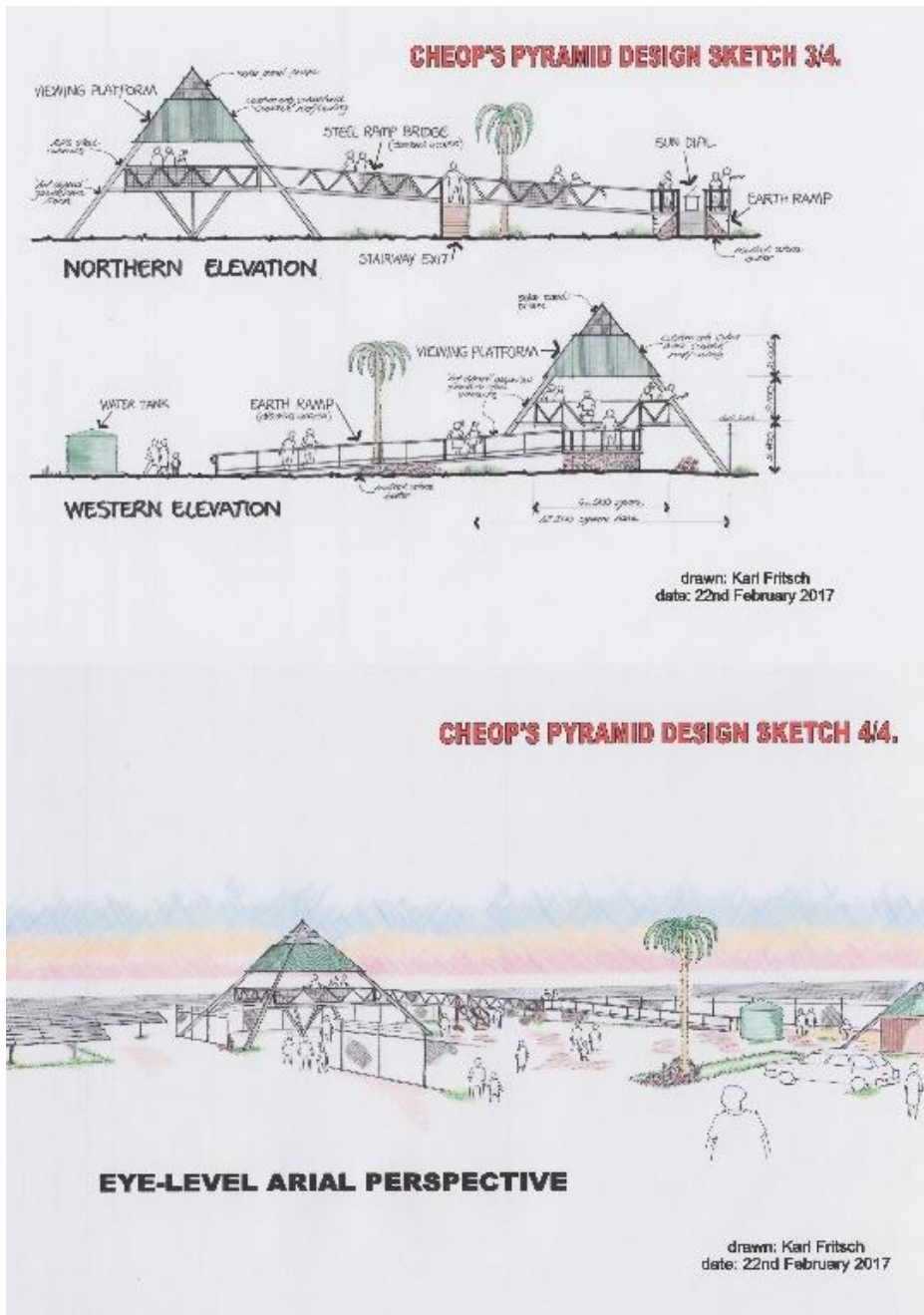

CONSTRUCTION MATERIALS

Specifically, only low maintenance materials are used in this design i.e. Hot-dipped galvanised steel, colour bond iron for roof/ceiling and a concrete footing base.

DESCRIPTION

VIEWING PLATFORM

FEATURES:

- (1) The iconic pyramid form may be unique to identifying this site and any future replications.
- (2) Cheop's Pyramid Viewing Platform theme is conducive with the Egyptian culture of SUN worship.
- (3) Form and construction of the Viewing Platform is consistent with Broken Hill heritage of a mining winder head frame.
- (4) Upper Ramp Bridge runs parallel to the solar panel network display and may be used for additional viewing space when congested.
- (5) The design may be proportionately decreased or increased in size without affecting the final functional result.
- (6) The construction materials of galvanized steel and colorbond iron ensure a maintenance free tenure.

- (7) All design and construction is in accordance with the Building Code of Australia and Disabled Access conformity.
- (8) A preliminary 'opinion of cost' tabulation suggests the design will meet the budget criteria.
- (9) The incorporation of the Disabled Toilet facility and water tank are entirely optional.

BIOGRAPHY: Have been a local resident of Broken Hill for the past 37 years and owner/manager of the firm Kenx Design Associates Pty Ltd – Architectural Consultants & Project Managers. Educated in Adelaide (Dip. Arch. Tech.)

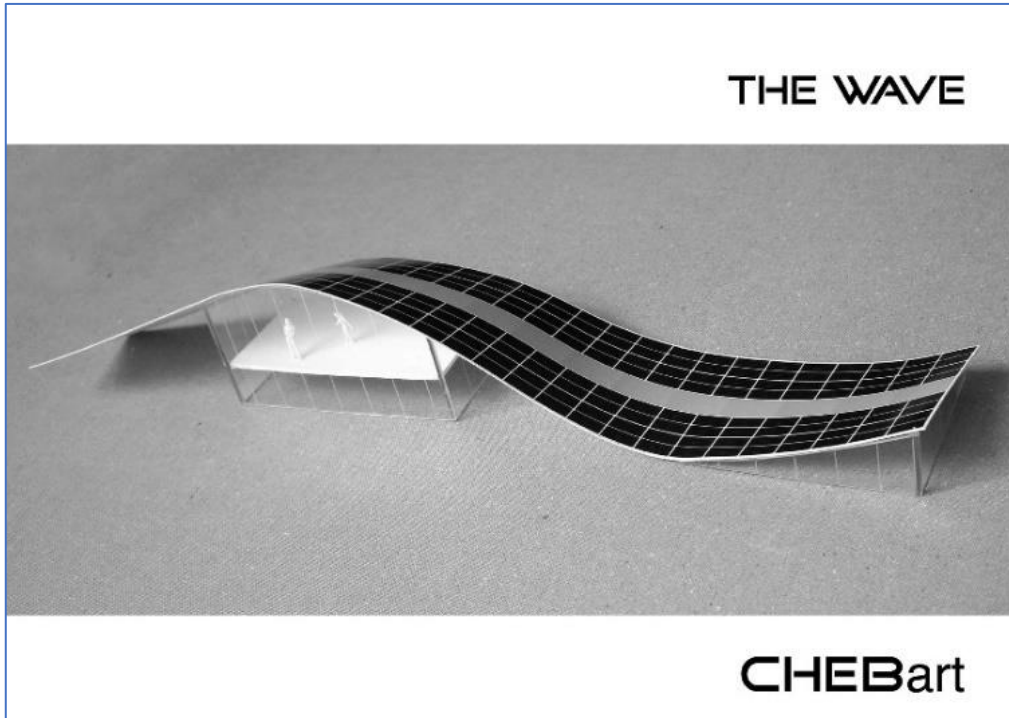

CONSTRUCTION MATERIALS

In keeping with the concept (that the shelter resembles a row of panels lifted) it is important that the structure has the same material aesthetic as the rest of the solar farm. We imagine a beautiful industrial structure using a combination of galvanized steel, glass and solar panels.

DESCRIPTION: Our idea is a direct response to the site. The solar farm with its row upon row of solar panels creates a striking ground pattern. In its simplest form our idea is to lift one of the solar banks to create a roof that houses the viewing platform.

The form will be simple and will relate to the surrounding panels but also be an anomaly on the site - a wave in the desert. The viewing platform functions two-fold. The highest point of the raised solar panel bank allows us to build a structure underneath that will become the viewing and educational room for the solar farm. The curved roof has a walkway through the panels on the roof so the viewer can do a walkover of the solar hill in the desert environment. The walkway will be an extended ramp to allow access for all. This idea can be developed and manufactured at a number of different levels. It could be a roof system that simply covers a platform, to a roof system that houses a glass air conditioned building and educational centre. It is important that the building not only be environmentally sound but environmentally exciting. Built with working panels the building becomes its own living resource. This fact not only makes the building an independent cell but helps as an educational tool for a centre with integrity. The viewing platform faces the farm which allows the tilted roof of the viewing platform to face North as desired.

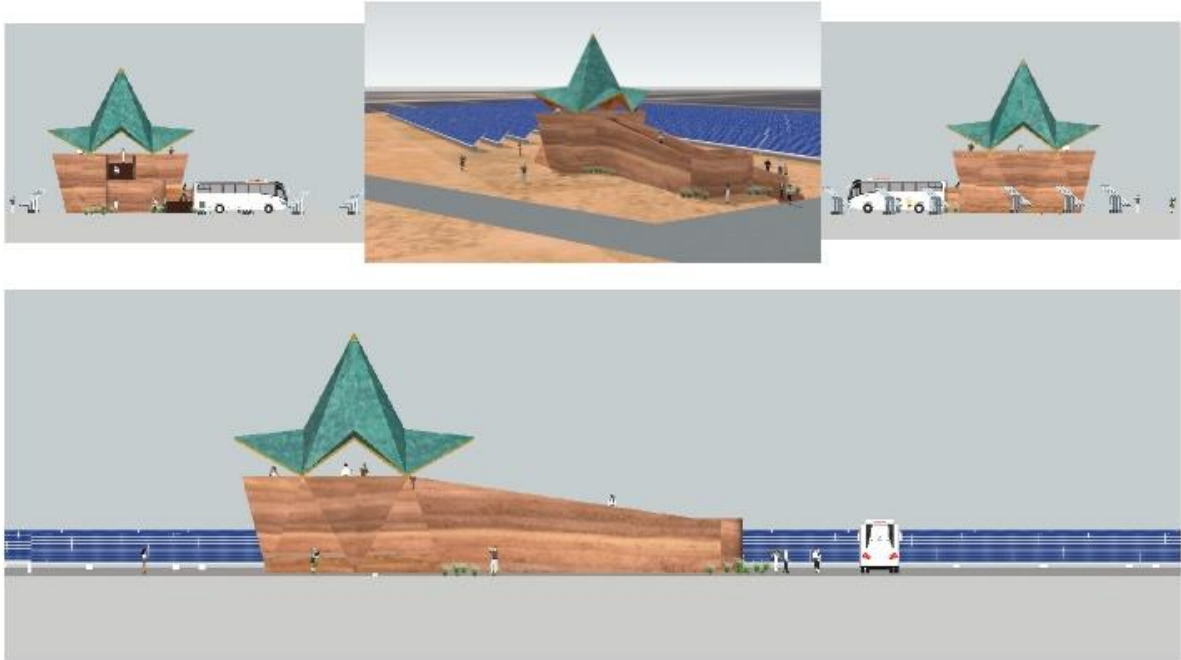
BIOGRAPHY: We operate an art and design business in Adelaide under the name of CHEB. CHEB stands for Christine and Deb. We started working collaboratively about 8 years ago, having realised it was much more fun to work together. Our background is in glassblowing but these days we work more on public commissions and product design. We have a fairly minimalist style but have also become known as artist who's designs respond strongly to place and function. We are very interested in the point where sculpture, architecture and function meet. That is what excited us about this project and what we have tried to embody in our design. We are inspired by the natural world and have always had a desire to work with solar panels and renewable energy in our designs. A project such as this would be a dream come true. We remember the first time we saw the 'Line of Lode Miners memorial' and how absolutely outstanding and brave the building is. We would like to be part of adding another iconic building to Broken Hill. We hope you like our idea and would be very happy to come up and talk to you about it further.



The Yuku AGI Viewing Platform

The platform acknowledges the original custodians of the land. Yuku is the Paakantyi word for sun. The ancient power of the Sun that sustains all life on Earth.

The base of the platform is made from rammed earth that has been strengthened with the addition of cement. The platform will appear to rise out of the countryside by using the very earth upon which it is built.

A grand ramp provides access for all those that come to see the massive solar array. The first rise of the ramp takes people to an

Information kiosk that is located beneath the viewing platform. Traveling further up the ramp takes you towards the canopy of the platform.

The viewing platform is crowned by a vault that is coated with copper. The pinnacle and the edges of the canopy are detailed in gold leaf. The interior of canopy is lined in steel sheeting with a rusted patina.

The star shaped structure is symbolic of the Sun. The shape is also designed to be reminiscent of the top of the Broken Hill Post Office Tower. The prismatic shape is also a nod to the crystalline structure of the rare 'native copper' that can be found in the region.

The canopy provides ample shade like a wide verandah or a broad brimmed hat. The materials used reflect the mineral abundance of the region.

Yuku is a celebration and a tourist destination. A place to observe a landmark solar array. What better way to view a landmark... than from a landmark itself?

© 2017
All designs created by Graham Wilson



CONSTRUCTION MATERIALS: The base of my design would be made with rammed earth that has been strengthened with the addition of concrete. Rammed earth uses the local earth (see examples here <http://www.stabilearth.com.au>, http://olneerammedearth.com.au/?gclid=CPHx6KuAqNICFYiAvQodZ8MC_A) This reduces the cost of sourcing and transporting materials. Rammed earth is also an excellent thermal insulator. The base of the structure would be cool and comforting and the colours would be a perfect match for the surrounding landscape. Rammed Earth walls require substantial formwork. If the cost was prohibitive then the walls could be made from stabilised mud brick or random rubble stone walling. Another experimental option could be the use of large scale 3D printing using the local soil and a bonding agent. (<http://inhabitat.com/worlds-largest-delta-style-3d-printer-can-print-nearly-zero-costhousing-out-of-mud/>) This innovative method could create an immense amount of publicity and substantially reduce construction costs. The Canopy would be constructed from a wood or steel frame that is clad in Copper sheeting on the outside and steel sheeting on the inside. The canopy is designed to have a golden tip that serves as a decorative flourish and caps the structure whilst concealing an air vent at the apex of the piece. The ramp could be paved with local bricks or random stone paving.

DESCRIPTION: The platform acknowledges the original custodians of the land. Yuku is the Paakantyi word for sun. The ancient power of the Sun that sustains all life on Earth. The base of the platform is made from rammed earth. The platform will appear to rise out of the countryside by using the very earth upon which it is built. A grand ramp provides access for all those that come to see the massive solar array. The first rise of the ramp takes people to an information kiosk that is located beneath the viewing platform. Traveling further up the ramp takes you towards the canopy of the platform. The viewing platform is crowned by a vault that is coated with copper. The pinnacle and the edges of the canopy are detailed in gold leaf. The gold represents the colour of the sun and the wealth provided by the region. The interior of canopy is lined in steel sheeting with a rusted patina. The star shaped structure is

symbolic of the Sun. The shape is also designed to be reminiscent of the top of the Broken Hill Post Office Tower. The prismatic shape is also a nod to the crystalline structure of the rare 'native copper' that can be found in the region. The canopy provides ample shade like a wide veranda or a broad brimmed hat. Yuku is a celebration and a tourist destination. A place to observe a landmark solar array. What better way to view a landmark than from a landmark itself?

BIOGRAPHY: I am married with three children. I am originally from Gunnedah, NSW, but I have lived in Newcastle for over 30 years. I have been a practicing artist for almost 35 years. I trained at TAFE and University where I majored in Printmaking. Initially I specialised in large scale woodcuts. The more I worked with wood the more I realised that I liked the woodblock more than the actual print. I began to focus on creating woodcuts where I exhibited the wood itself rather than a print from the wood. My work would often contain an environmental message. I produced a series of images that featured the Greenman (a name given to foliate heads or heads that had leaves coming out of their mouths). The Greenman is often featured in architectural carving. This interest made me study as a stonemason and eventually led me to work in the Cathedral workshop in Trondheim, Norway. For a long time, I have worked in many fields. I have taught Art and Graphic Design. I produce computer graphics and illustrations. I paint in oil. I am a set designer, a stone carver, and an actor. I have a passion for architecture, but I am only an amateur.

13

**AGL SOLAR FARM
VIEWING PLATFORM
BERNARD WILLIAMS**

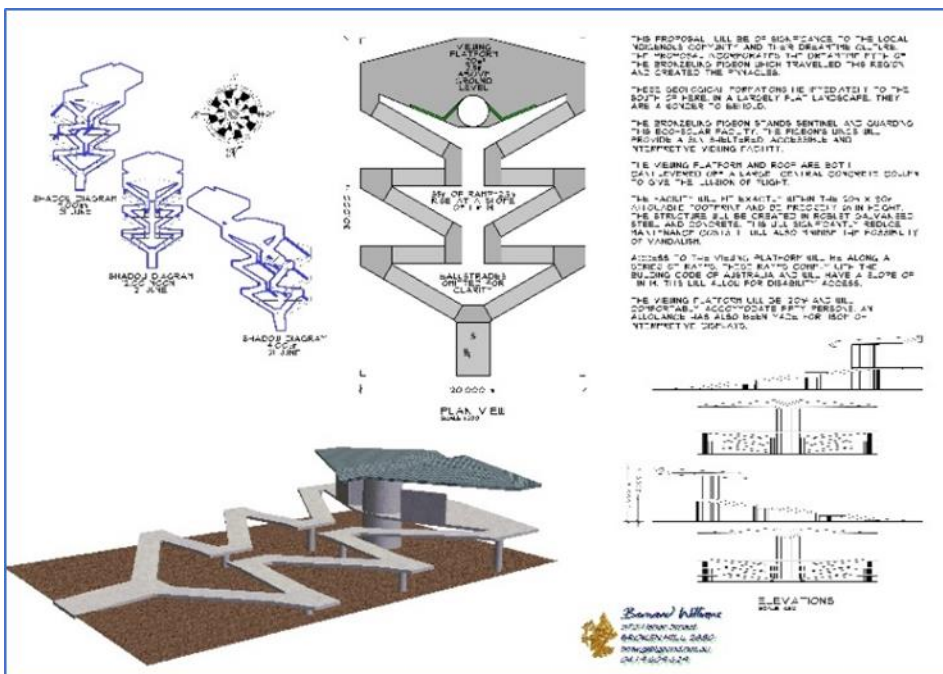

CONSTRUCTION MATERIALS

Reinforced concrete, Galvanised Structural Steel. By using these materials, it will significantly reduce maintenance costs and will also minimise the possibility of vandalism.

DESCRIPTION: This proposal will be of significance to the local indigenous community and their dreamtime culture. the proposal incorporates the dreamtime story of the bronzewing pigeon which travelled this region and created the pinnacles. these

Geological formations lie immediately to the south of Broken Hill in a largely flat landscape. they are a wonder to behold. the bronzewing pigeon stands sentinel and guarding this eco-solar facility. the pigeon's wings will provide a sun sheltered, accessible and interpretive viewing facility. the viewing platform and roof are both cantilevered off a large central concrete column to give the illusion of flight. the facility will fit exactly within the 20m x 30m allowable footprint and be precisely 6m in height. the structure will be created in robust galvanised steel and concrete. this will significantly reduce maintenance costs. it will also minimise the possibility of vandalism. access to the viewing platform will be along a series of ramps. these ramps comply with the building code of Australia and will have a slope of 1 in 14. this will allow for disability access. the viewing platform will be 120m,, and will comfortably accommodate fifty persons. an allowance has also been made for 7sqm of interpretive displays.

BIOGRAPHY: I arrived in Australia from England on the ship SS Orontes with my parents in 1955 and for twelve months I resided in Adelaide before moving to Jamestown in SA. I commenced and completed my schooling in

Jamestown then started work in the local butcher shop. in 1964 at the age of 15 years I moved to Broken Hill and commenced employment as an apprentice carpenter/cabinet maker with home joinery works. In 1970 I was employed at the Broken Hill City Council constructing concrete roads/kerbs and footpaths. My position was later upgraded to buildings maintenance carpenter to maintain all of council's buildings. Over the years due to much change within the organisation again a position was offered to me as trade supervisor for buildings. I was then offered the position of asset planner for buildings and in charge of contractors and large projects involving the Broken Hill Film Studio and the Regional Aquatic centre and various other projects totalling fifteen million dollars. I was responsible for organising the first Rock-On mineral show at Silverton via Broken Hill which brought many collectors to our wonderful city. In 2014 I retired after 44 years with the Broken Hill City Council.

My hobbies are: Collecting - fine minerals and crystals specimens from all over the world Designing - making wooden projects as I have a passion for wood. Travelling- Having been to South America and swam with the pink dolphins in the Amazon river these are some of the rarest dolphins in the world. I love to travel around Australia whenever I get the opportunity. Camping - In the outdoors of Australia taking in the beautiful scenery that this wonderful land has to offer Cooking – I enjoy cooking, growing my own vegetables and herbs in my garden as well preserving what I grow, I have written my own cook book and maybe one day it will be published.

14

SOLAR HOUSE STEPHEN WARBURTON

CONSTRUCTION MATERIALS

Solar panels and steelwork. Being exposed to the weather this construction would last the time.

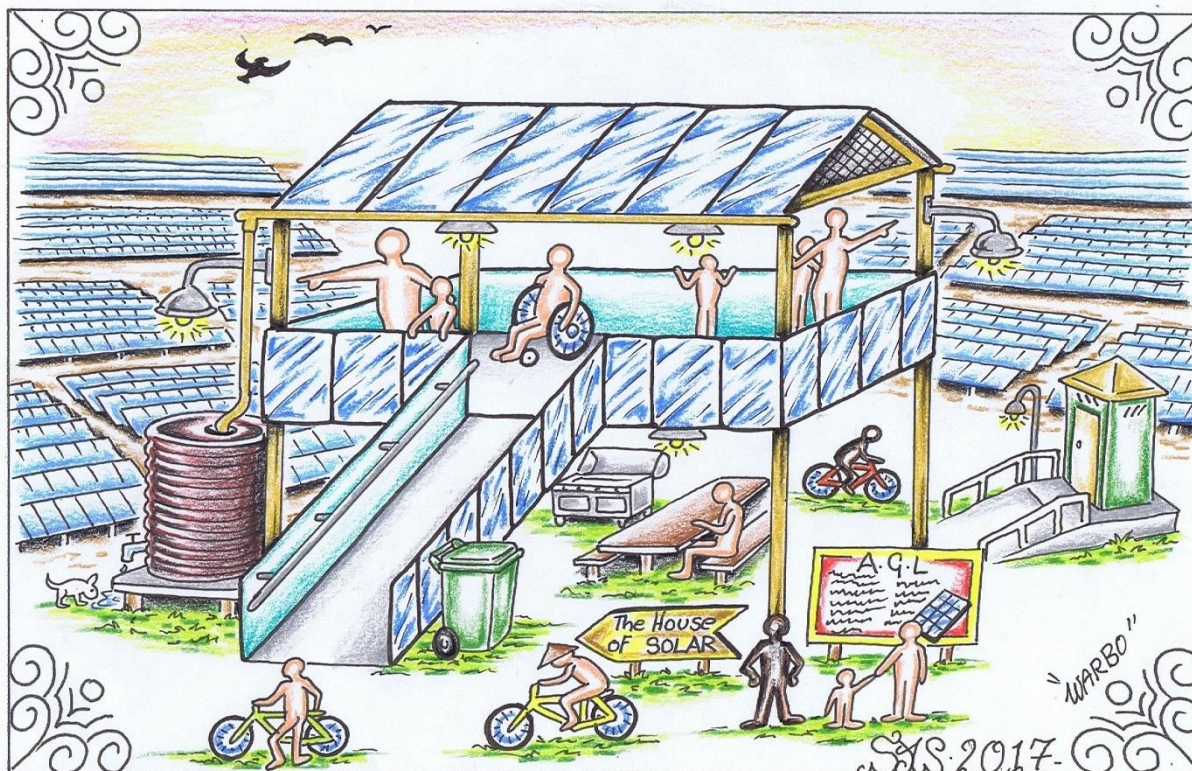

DESCRIPTION

A house platform made all from solar panels.

BIOGRAPHY

I'm a 58-year-old male who has been born and bred in broken hill, and would love to see more of this innovative construction in the area Inside the house could be diagrams and descriptions of how solar works.

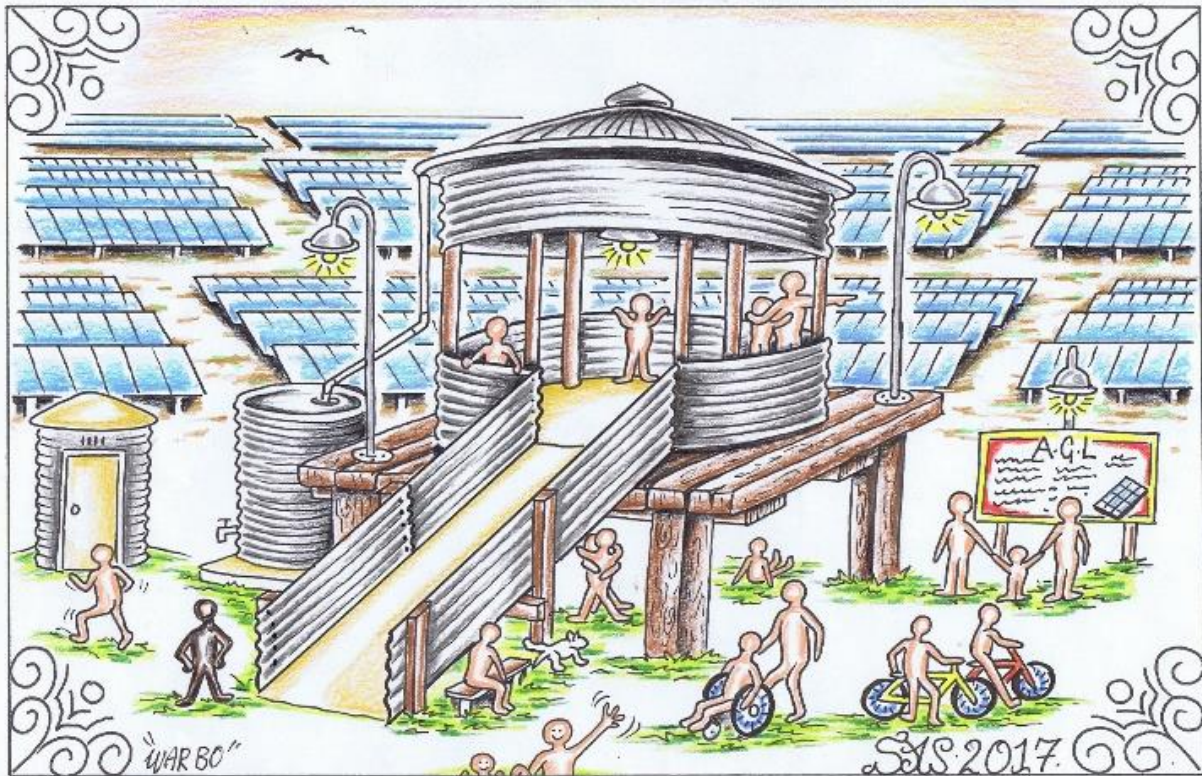

WARBO
235 Duff Street
Broken Hill N.S.W 2880
TEL: 08-80882703

CONSTRUCTION MATERIALS

Timber and corrugated iron, to give the authentic tank feel and look

DESCRIPTION

This has been designed with the true outback in mind, an iconic rainwater tank

BIOGRAPHY

I'm a 58-year-old male who has been born and bred in broken hill, and would love to see more of this innovative construction in the area

CONSTRUCTION MATERIALS

The main structure of the ramp will be steel. This is a large piece on engineering that will have to be strong and accurate if it is to turn and rise. This sort of structure is synonymous with Broken Hill and mining. The underground portion of the structure is concrete. The drive system an electric motor governed by the output of the Solar farm. The motor will be directly geared to a rack mounted on the inside of the walkway, driving the helix up or down as the power from the farm varies during the day. All of the moving elements of the walkway are protected by balustrades. The motion will be slow and safe.

DESCRIPTION: Things that emerge from the Earth. This machine acts as a meter of the power generated by the Solar farm, making tangible the energy that is being created. At Dawn the platform lies dormant at ground level. As the sun rises and the solar cells go to work the platform beings to turn, winding itself up out of the earth and taking the observation deck towards the sky.

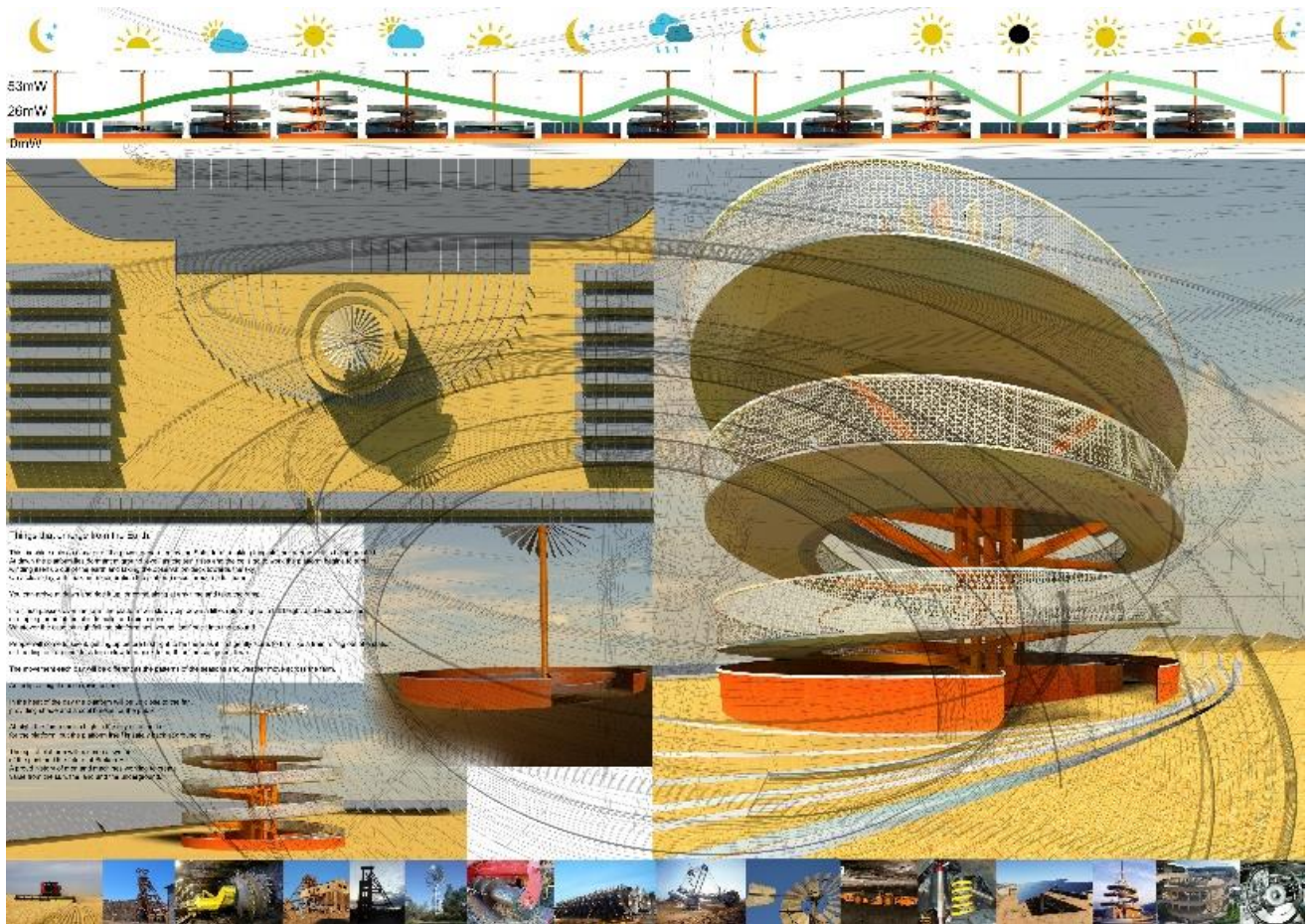

On a clear day with maximum generation the platform rises through 3 full turns. You can arrive at Dawn and ride it up, or come along at any time and take the ramp. If a cloud passes over the farm the platform will slowly dip down a little, returning up to full height as the cloud passes or dipping further if the clouds build and rain comes. Whatever the case, by nightfall the platform has wound itself back into the ground. People will come to see it, getting up before first light to be there as it first gently starts to turn like a train rolling out of a station or heading out around dusk for a slow turn back to earth as the sun goes down. The movement each day will be different as the patterns of the seasons and weather move across the farm. An eclipse might need crowd control. In the heat of the day the platform will be up close to the fan, providing shade and a cool breeze for the public. At night, the fan remains high in the sky as a marker for the platform, but the platform itself is safely back at ground level. The spiral platform will become a symbol of the past and the future of Broken Hill. A proud history of men and machines working to create value from the sun, the land and the underground.

BIOGRAPHY: I'm an Architect who works mainly on large infrastructure, Airports, Railways and Stadiums. I'm interested in large structural / mechanical items and our collective fascination with them. We may have moved into a digital age but a childlike fascination remains (for most of us) with bridges, ships and huge mining equipment. A lot of my work has explored making engineering elegant as well as functional. I've sought to do this through honesty of structure that clearly demonstrates its purpose.

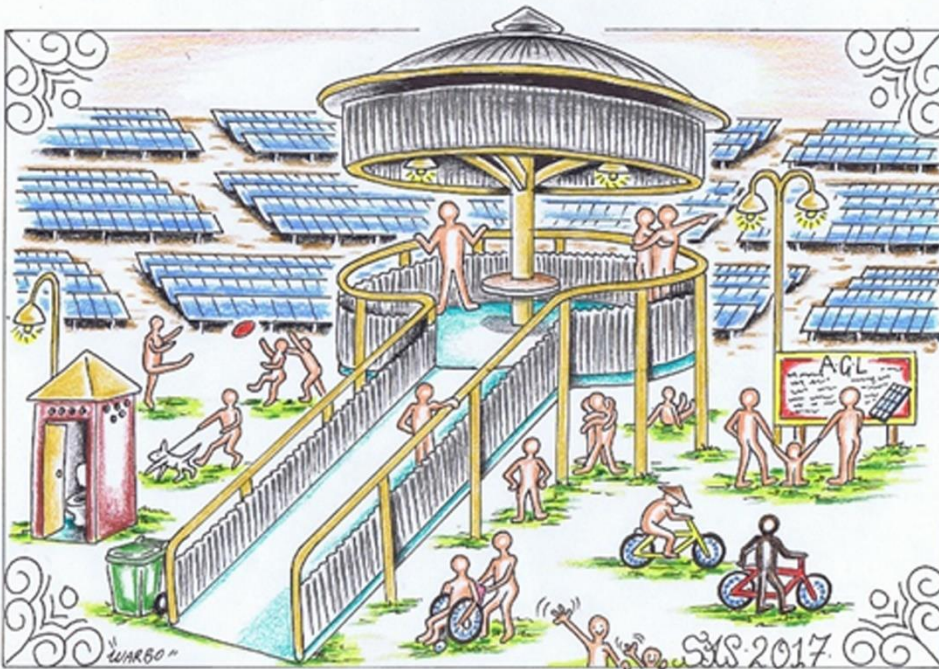

CONSTRUCTION MATERIALS
Steel and iron.

DESCRIPTION
This work has been designed with a futuristic feel.

BIOGRAPHY
I'm a 58-year-old male who has been born and bred in broken hill, and would love to see more of this innovative construction in the area

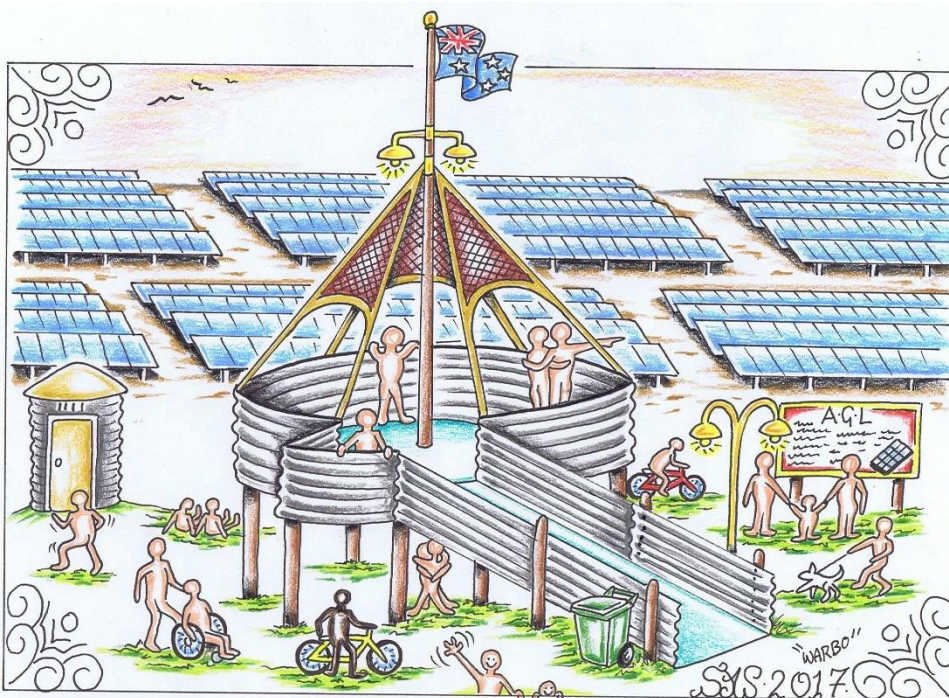

CONSTRUCTION MATERIALS
Timber, corrugated iron and shade sail.

DESCRIPTION
This work has been designed with an outback feel.

BIOGRAPHY
I'm a 58-year-old male who has been born and bred in Broken Hill, and would love to see more of this innovative construction in the area

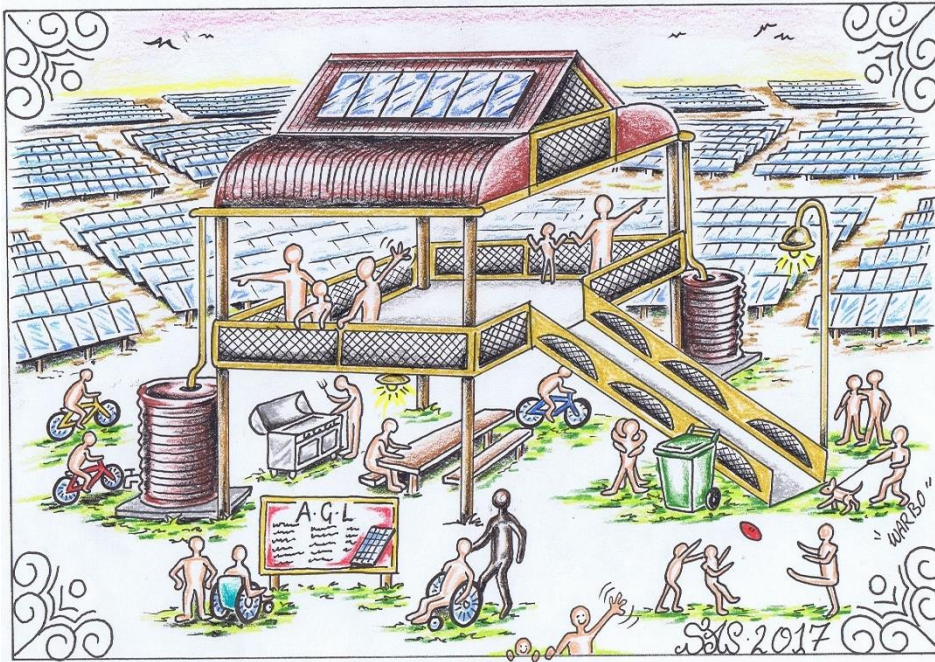

CONSTRUCTION MATERIALS
 Timber and corrugated iron and cyclone wire.

DESCRIPTION
 This work has been designed with the true outback in mind, an iconic homestead.

BIOGRAPHY
 I'm a 58-year-old male who has been born and bred in Broken Hill, and would love to see more of this innovative construction in the area

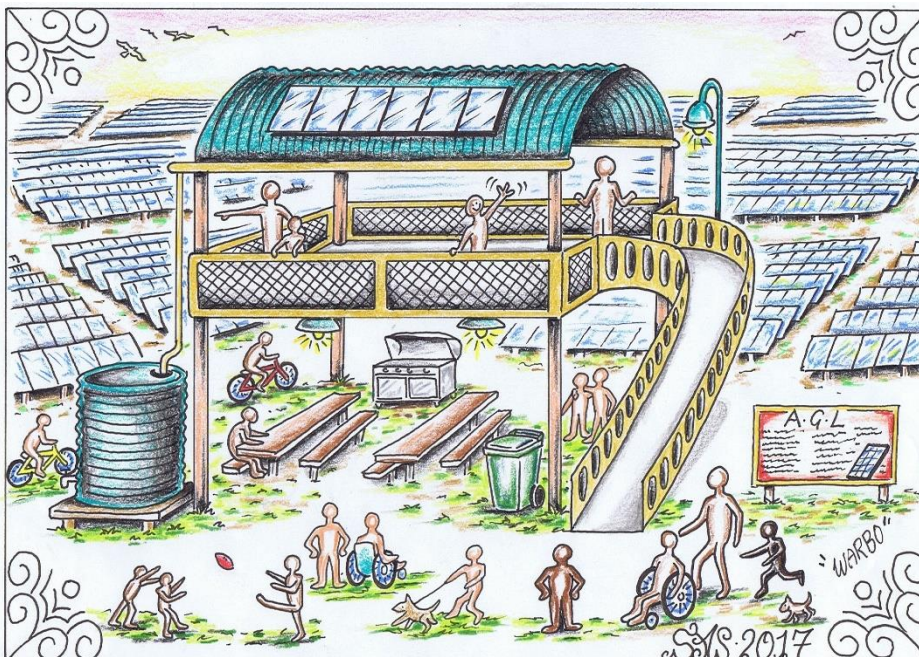

CONSTRUCTION MATERIALS
 Steel and timber

DESCRIPTION
 This work has been designed with the true outback in mind

BIOGRAPHY
 I'm a 58-year-old male who has been born and bred in Broken Hill, and would love to see more of this innovative construction in the area

21

THE POWER HOUSE STEPHEN WARBURTON

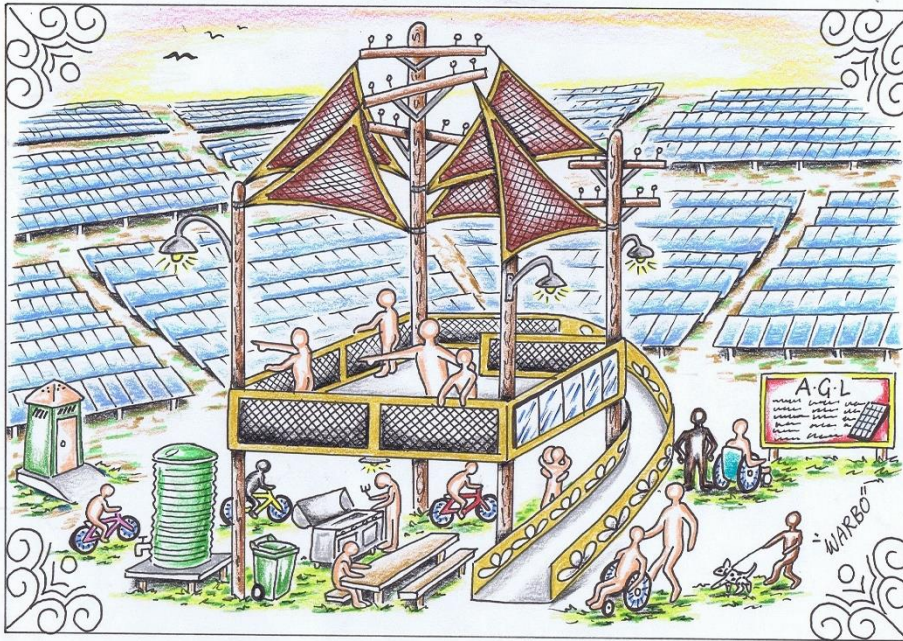

CONSTRUCTION MATERIALS
Power pole, steel shade sails mesh. And the ceramic tope of power lines (sic).

DESCRIPTION
This has been designed with old technology paving the way to new.

BIOGRAPHY: I'm a 58-year-old male who has been born and breed in broken hill, and would love to see more of this innovative construction in the area

22

THE VIEW STEPHEN WARBURTON

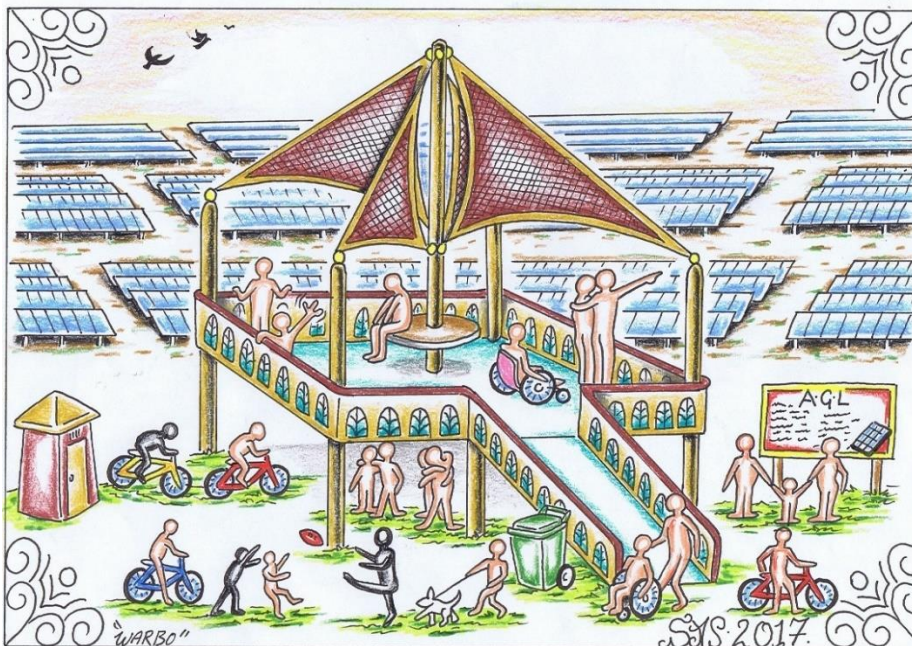

CONSTRUCTION MATERIALS
Timber, steel work, wrought iron arches and shade sails.

DESCRIPTION
This has been designed with simplicity in mind

BIOGRAPHY
I'm a 58-year-old male who has been born and breed in broken hill, and would love to see more of this innovative construction in the area

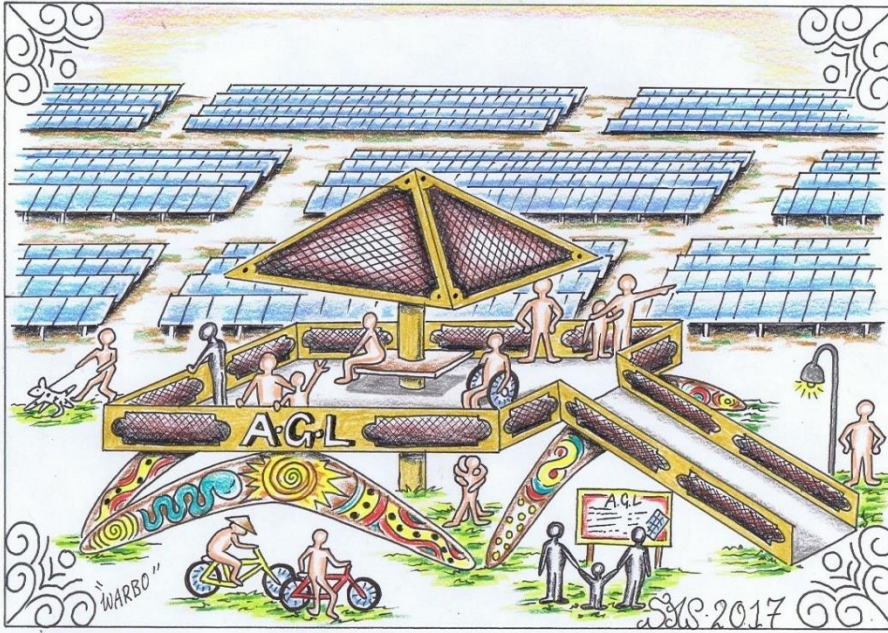

CONSTRUCTION MATERIALS
Steel, timber and concrete.

DESCRIPTION

This has been designed with Australia in mind. It has a boomerang design base with a hills hoist feel rooftop with a colonial balcony.

BIOGRAPHY

I'm a 58-year-old male who has been born and bred in Broken Hill, and would love to see more of this innovative construction in the area

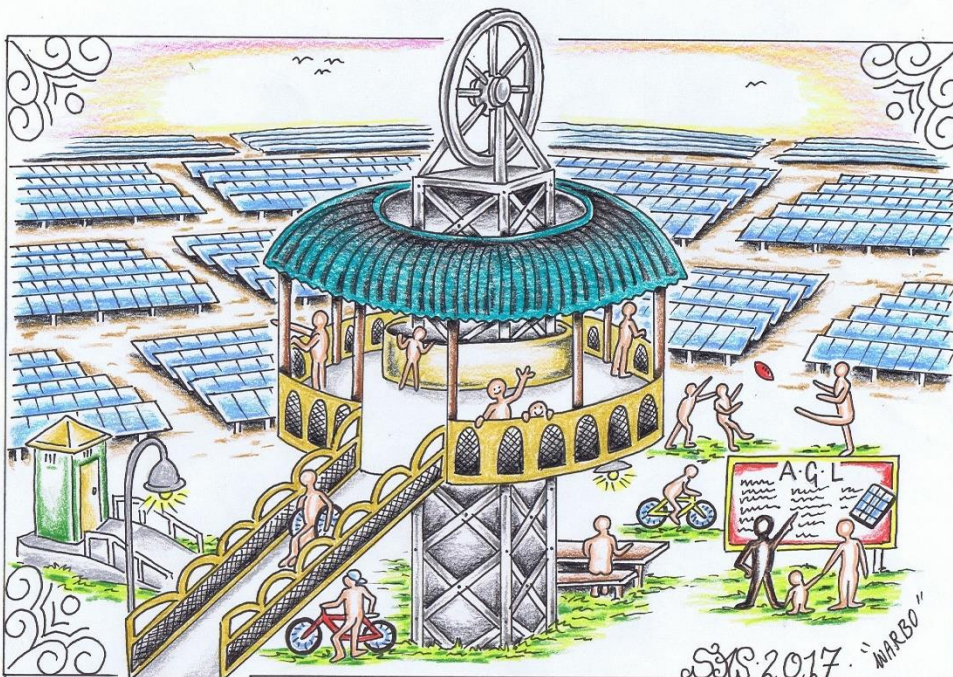

CONSTRUCTION MATERIALS
Steel, timber and iron.

DESCRIPTION

This has been designed with BROKEN HILL'S mining heritage as a feature being a mine poppet head but with a 360degree heritage veranda.

BIOGRAPHY

I'm a 58-year-old male who has been born and bred in Broken Hill, and would love to see more of this innovative construction in the area

25

THE SHAFT
STEPHEN WARBURTON

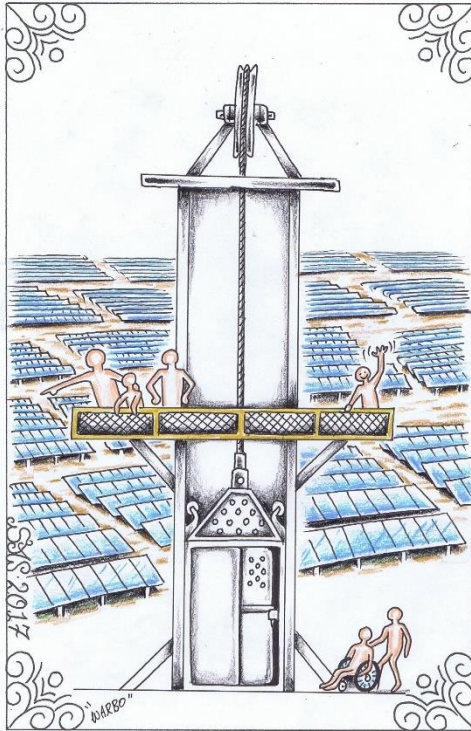

WARBO
235 Duff Street
Broken Hill N.S.W 2880
TEL: 08 8089 2765

CONSTRUCTION MATERIALS

Steel

DESCRIPTION

This has been designed with BROKEN HILL'S mining heritage as a feature being a mine shaft design

BIOGRAPHY

I'm a 58-year-old male who has been born and bred in broken hill, and would love to see more of this innovative construction in the area

26

THE PLATFORM
STEPHEN WARBURTON

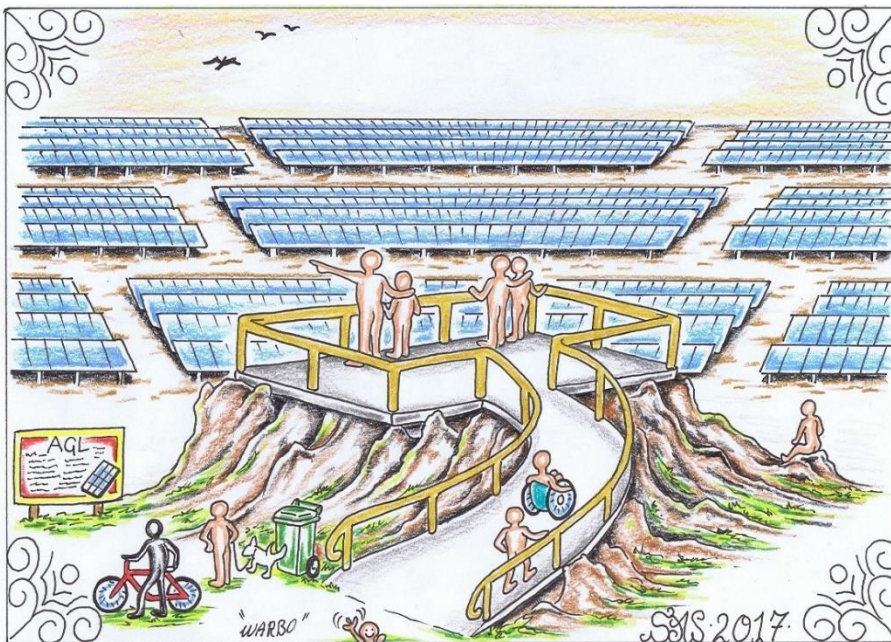

CONSTRUCTION MATERIALS

Dirt, concrete base and hand rail.

DESCRIPTION

Simplicity and functional with an uluroo look (sic)

BIOGRAPHY

I'm a 58-year-old male who has been born and bred in broken hill, and would love to see more of this innovative construction in the area



'The Solar Serpent'
John Hayward 2017

CONSTRUCTION MATERIALS

The landform could be made from local land-fill material topped with a hard surface to form both a good path and a structural base on which to locate the sculptural ribs of the serpent. I propose that the curved ribs be made from cross laminated timbers (CLT) with a durable finish, and secured to the landform path with galvanised steel brackets. Engineered timbers, such as CLT, are extremely strong, stable and durable, even in extreme climatic conditions. They are currently being used as the preferred construction material for many high-rise timber buildings in Australia and world-wide. CLT is an environmentally

friendly material that has a lower carbon footprint than other building materials, a production process that produces zero waste, and timbers which are sourced from certified sustainably-managed forests. They store carbon and produce less CO₂ during their lifetime than other materials. Timber is the obvious material to celebrate a solar collecting facility as trees have a symbolic relationship to solar collectors in that the leaves of a tree convert light into energy through direct contact with sunlight, much like solar panels converting sunlight into electricity. I have successfully used CLT sourced from Europe for a large sculptural installation at the new Royal Adelaide Hospital called the 'Bower Walk' and therefore have an understanding of both the logistics and costs of using this material. www.thebowertowerproject.com/news.html or www.hess-timber.com/en/projects/timber-architecture/detail/sculpture-the-new-royal-adelaidehospital/

DESCRIPTION of your art / design work The Solar Serpent rises from the land to provide an exciting and interactive experience for viewing the AGL solar plant from an elevated platform. Visitors to the site will walk from the car park along a path through the ribbed form of the serpent that slowly rises to its head where an unrestricted view of the solar plant is possible. The entrance to the body of the serpent is open and welcoming and closes around the visitor as they proceed towards the head. The serpent has 37 curved rib forms. The viewing platform at the head of the serpent has a shelter which houses interpretive panels about the AGL solar array, the roof of which is itself a solar collector that powers LED lights located on each of the serpent's ribs. There is a potential for a spectacular night time light display along the sculptural ribs. The landform has an inclined path on which the serpent structure is secured that rises from ground level to around four meters over a 50-meter length (approximate). The size of the landform would fit within the 20 x 30 m footprint stipulated in the brief. This structure makes reference to the mullock heap, the mine residue hill, that dissects the city of Broken Hill. It is suggested that the viewing area be secured with a fence or railing around the perimeter.

BIOGRAPHY I am a designer/maker/artist with an interest in anthropology and archaeology. I attended the North Adelaide School of Art during the 1980s and 90s and have been an active practitioner since then. The main focus of my art practice has been environmental sculpture and I have shown at many of the Heysen and Palmer sculpture biennials in the past few years. I am involved in an ongoing investigational art project called the Bower Tower Project with Ian Hamilton that looks at the role of timber as both a symbolic and construction material for art and architecture. www.johnhaywardsculpture.com

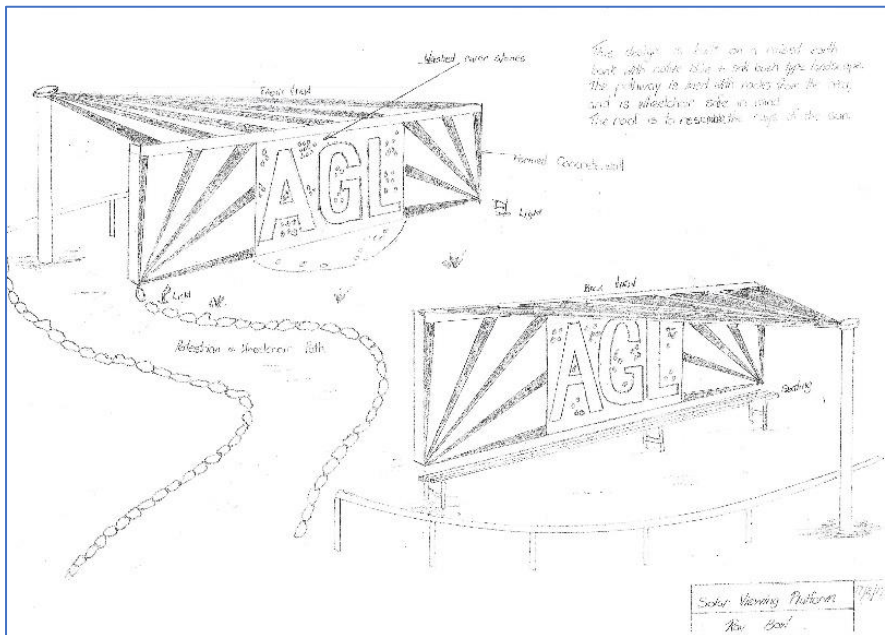
**CONSTRUCTION MATERIALS**

The design is built on a raised earth bank with native blue and salt bush type landscape. The pathway could be of crushed rock and lined with rocks from the area and is wheelchair safe. There is seating for people to admire the solar farm. The roof is to resemble the rays of the sun and made from structural steel. The wall itself is made of pre-formed concrete panels with washed river stones embedded in and around the AGL initials.

BIOGRAPHY

I'm a retired miner and former locomotive maintainer. I have lived in Broken Hill since the 1960's, married to a local girl and have two adult children

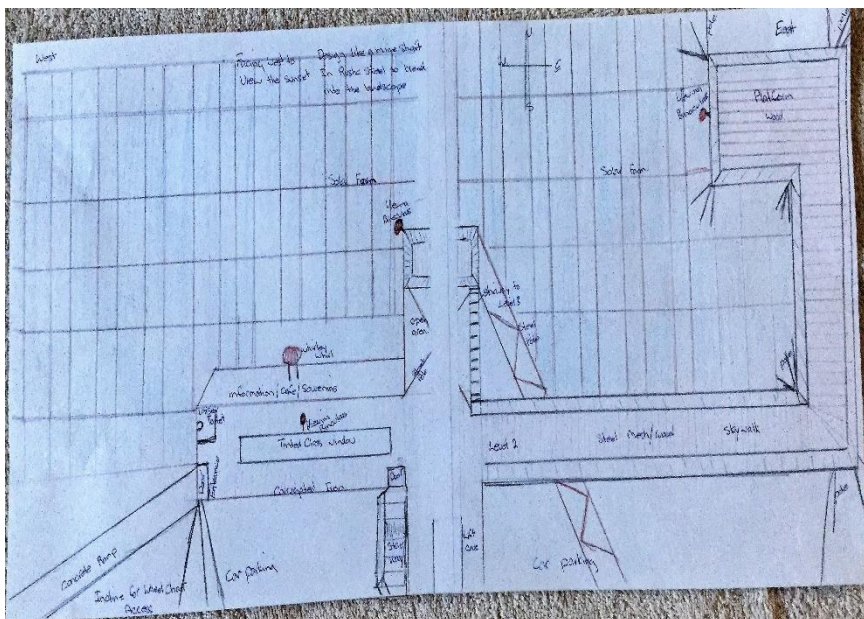

CONSTRUCTION MATERIALS: Rustic Steel, wood and tinted glass. We chose these materials because of the extremes of the climate

DESCRIPTION: The design features an old head frame with a viewing platform and sky walk which incorporates a cage lift, ramp, coffee shop and information area.

BIOGRAPHY: We are two passionate ceramic artists, who see an opportunity to incorporate Broken Hill's history and new age technology together in one place. We are both 4th generation Broken Hill Residents who would like to see a structure that depicts our area as we live in a heritage listed city.

© Allan Giddy



CONSTRUCTION MATERIALS: Earth, treated steel, water treatment filters, solar modules, a regulator and wiring, water, native flora and fauna. Reasons for materials choices: Resilience: Australian-made shade cloth 'Montotec 370' has a 15-year UV warranty. The treated steel structure supporting it will be good for many years beyond that. This shade will be storm-proof to 140mph. Change: The earthwork component will change and grow with time; I intend that flora will be native and local, and include 'bush tucker'. Advice will be sought from local flora and fauna experts, including indigenous leaders, to ensure appropriateness of planting. Arrival of fauna is inevitable and desirable. Nourishment: Filtered bore water is preferred, although there are other options. Power: Power systems are low wattage. The artist holds and electrical licence, and has a comprehensive understanding of how and where they might be used. A small system can be quickly developed to serve the needs of this installation, following consultation with AGL regarding position and water proximity (or otherwise) Context: Material used for the creation of the shadow lines will be defined after consultation with AGL. Material for the historical time line will be developed in consultation with UNSW solar researcher (participation already confirmed). A key and explanatory diagram will be mounted on the viewing platform. Cold potable water delivered at the base of the shade structure will have been drawn, treated and cooled by solar power. Aside from this historical text there, will be text at the commencement of the path reading:

"All material in nature,
The mountains and the streams and the air and we,
Are made of Light which has been spent,
And this crumpled mass called material casts a shadow,
And the shadow belongs to light." Louis Kahn

DESCRIPTION: Shelter creates shade - Australia's solar story, narrated each day in shifting shadow - Shelter creates power - Delivering cool, drinkable water. This work will consist of large mound of earth, with a curled track which will ascend gently from the ground to a height of four metres. Visitors will be able to walk up the curl. I on the sheer edge at the top closest to the power station, an elegant two-tiered shade structure will be built. This structure will provide both shade, and a view over the power station. As each day unwinds, this shade structure will cast an ever-moving shadow across a set of reference 'shadow lines' on the surface of the land surrounding it. Each line will represent a milestone in the history of solar energy, from its earliest days through to the construction of AGL's ground breaking solar power station. It will be the 'history of solar written in a day's changing shadow'.

BIOGRAPHY: New Zealand-born sculptor Allan Giddy lives and works in Sydney, Australia. Allan's 22 years working with solar energy* in art and 12 years working closely with the community in Broken Hill makes him a perfect fit for this project. Allan's pioneering use of solar systems and light in 'time-based sculpture' began in 10092. Over time his practice has expanded into the public domain, specifically public sited 'active sculpture' aimed at the reinvigoration of public spaces. He is one of Australia's foremost proponents of sustainable energy systems, electronic interconnectivity and interactivity embedded in the physical art object. His work has been shown in ISEA and TISEA (International Symposium on Electronic Art), at the Tate Modern, and in numerous other venues internationally, from Canada and Finland to Greece, Vietnam and Bulgaria. In recent years, he has completed a number of large public commissions, in Australia, China, Ireland, Germany, the UK, Turkey and New Zealand. Allan has also directed and co-curated energy-in-art exhibitions at UNSW's Solar Research Centre (SOLARCH), Little Bay, Sydney in 1999 and 2002 Australia's first solar exhibition 'Desert Equinox' Broken Hill in 2012, and 'La Lune: Energy Producing Art' in 2014, which was runner-up for 2 Australian Event Awards. In 2016 he was awarded 4 grants to bring about the acclaimed multinational installation 'Sonic Wells for Gallipoli'. He currently directs the Environmental Research Initiative for Art at UNSW Art and Design. *Allan often works closely with UNSW School of Photovoltaic and Renewable Energy Engineering

31

MODERN RESOURCE BRADLEY ESDALE

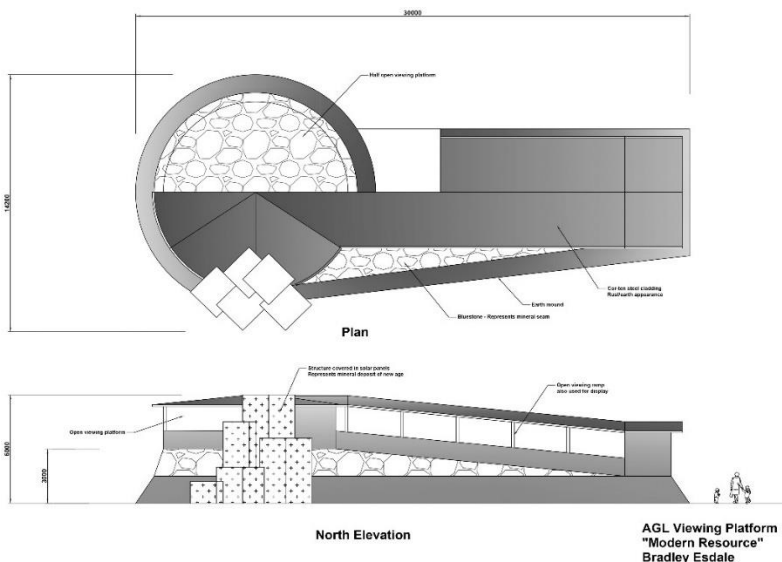

DESCRIPTION

Based on the local mining history this design is intended to reflect a mineral seam extending above the surface. The new resource, being solar energy, is shown in a sculptor in the form of a typical mineral crystal structure protruding out of the mineral seam.

CONSTRUCTION NOTES:

The bulk of the structure is an earth mound built up to provide the viewing height. Within the earth mound is a mineral seam, this is represented by the bluestone. At the end of the mineral seam is a sculpture in the form of a typical mineral crystal

structure. The sculpture is clad in solar panel (operational to provide power for access lighting), this represent the new age resource. The roof structure over the access ramp and half of the viewing platform is clad with Cor-ten steel which will corrode to an earthy brown colour. The sculpture is clad in solar panel (operational to provide power for access lighting), this represent the new age resource. The roof structure over the access ramp and half of the viewing platform is clad with Cor-ten steel which will corrode to an earthy brown colour.

BIOGRAPHY: Prior to commencing as a mechanical designer and project manager I was an aspiring artist. I love to repurpose industrial goods which is a combination of my mechanical and art background.

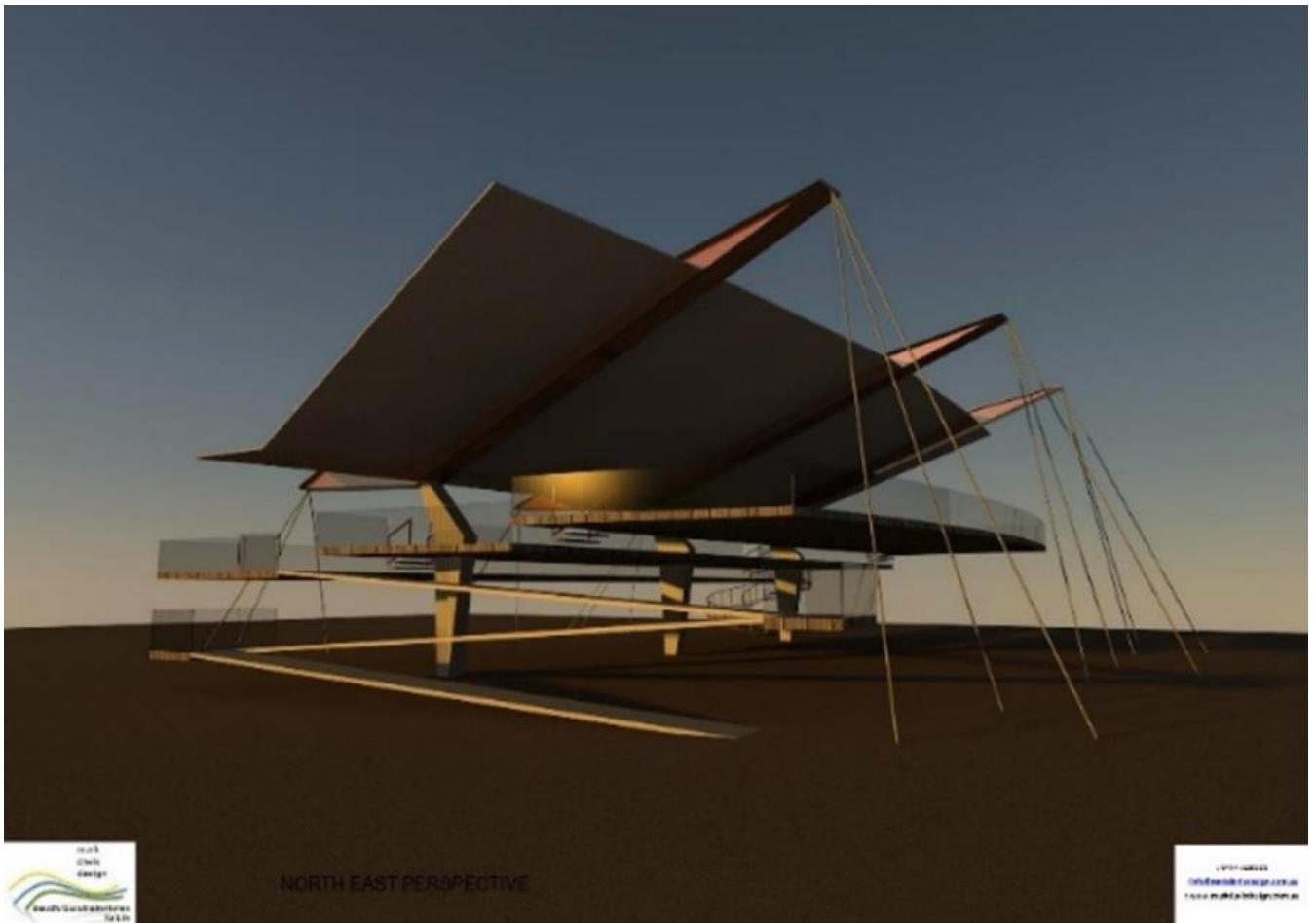
**DESCRIPTION:**

An eye-catching structure that appears to defy gravity. It lightly sits on the ground and soars towards the northern sun, paying homage to our new source of power! From approach, it is designed to draw the eye with its unique form; set against the harsh sun and vast desert plain. The structural aesthetic will further itself as visitors climb the stairs or ramp towards the platform. The main pillars and sculptural roof structure point to the northern and southern skies tapering to infinity. Upon arrival to the platforms, the structure gives way to the expanse of the solar array our energy future.

CONSTRUCTION MATERIALS

The structure reflects the history of Broken Hill, referencing its mining heritage and the origins of Australia's steel icon, BHP. Predominantly steel, the platform has recycled timber decking. Reminiscent of mining engineering in the area, all structures will be visible. The supporting structure is flexible it is able to be constructed from either heavy steel members or alternately a light framing clad in steel to rust naturally. The cabling is both structural and references the cable and pulley systems used in the mines.

BIOGRAPHY: I am a Building Designer based in the Blue Mountains. The focus of my work is Sustainable Residential Design; making sure homes are naturally warm and cool as required. I am also an Artist Blacksmith, creating sculptures and sculptured furnishings using iron and various steels, as well as other complimentary materials such as stone and timber. As such, this is a wonderful opportunity to combine my interests and talents, in the design of a large-scale sculpture that is also a public building; one that showcases an important part of our future energy and celebrates the transition in Broken Hill from mining to renewable energy. It is very exciting!

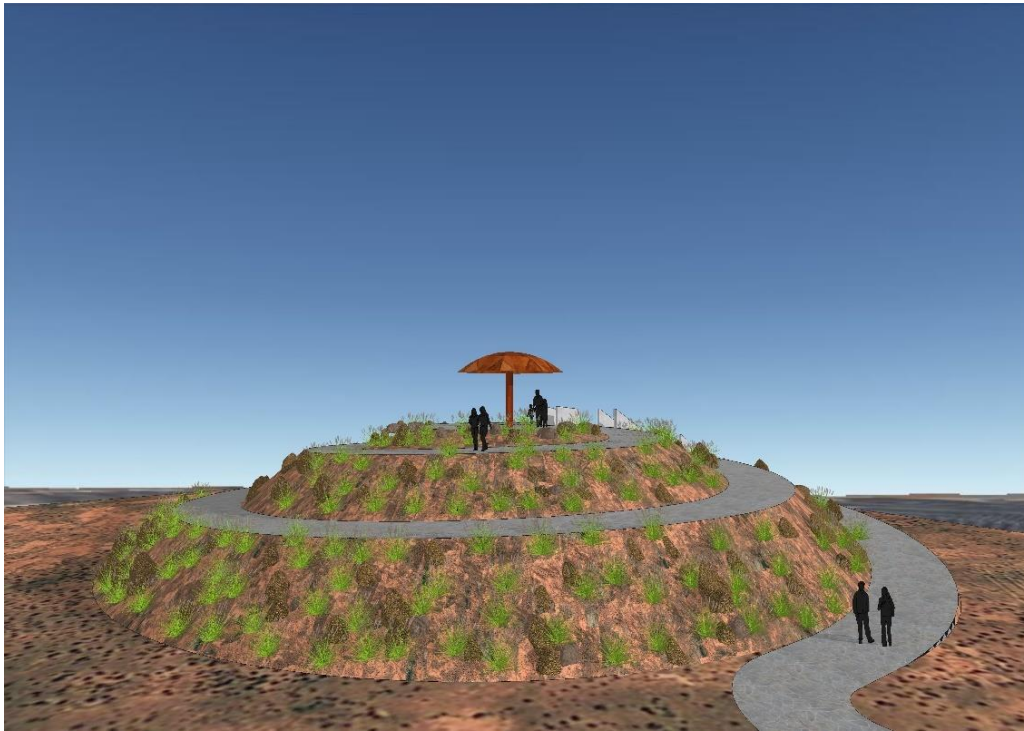

DESCRIPTION: Thoughts of Broken Hill conjure thoughts of red soil laced with iron oxide, large open cut holes in the ground and overburden. The observation post for the solar array was conceived from the vision of the overburden being removed from the hole in one piece. A ribbon of roadway cutting its way down through the earth is inverted to be a pathway for people to circumnavigate a low mound at a slope of 1 in 20, sufficiently flat to allow wheelchair users to wind their way to the top.

Transverse stairs allow the able bodied to take a more direct path. Environmentally the use of soil from excavation was an obvious starting point. It is left over from mining, fairly inexpensive, easily shaped and worked, of the immediate surroundings and able to be moulded to the shape required. Indigenous grasses and shrubs are envisaged for the slopes mixed with local stone to ensure the structural integrity of the slopes. A level area at the pinnacle 6 metres diameter is provided with an umbrella for shade made from core ten steel to cap the bulge and to eventually fade into the landscape.

BIOGRAPHY: I am an Architect and operate a sole practitioner from Hendra in Brisbane. I have been in private practice since 1992 and worked on residential, small commercial and interior fit out projects. I'm also an Access Consultant having been awarded a certificate 4 in access Consulting in 2015.

34 – FINALIST & PEOPLE'S CHOICE

SILVER CIRCLE VIEWING PLATFORM BEN WATERS (OSK Architects)



CONSTRUCTION MATERIALS

Lightweight perforated aluminium (other options to explore also) panels, landscape paving, palm and flower garden, W/C timber structure. The perforated lightweight structure provides shade and allows air to ventilate through its canopy. Its reflective surface reduces the heat gain under the structure, and provides a cool space to view the solar array from.

DESCRIPTION: Silver Circle Viewing Platform overlooks the Broken Hill solar farm and the Australian desert landscape. It is a constructed representation of an optimistic turn toward the future, celebrating new relationships between landscape and technology. It consists of 2 basic built forms – an artificial mound of earth forming a ramp, and a suspended silver ring that shades the viewing area.

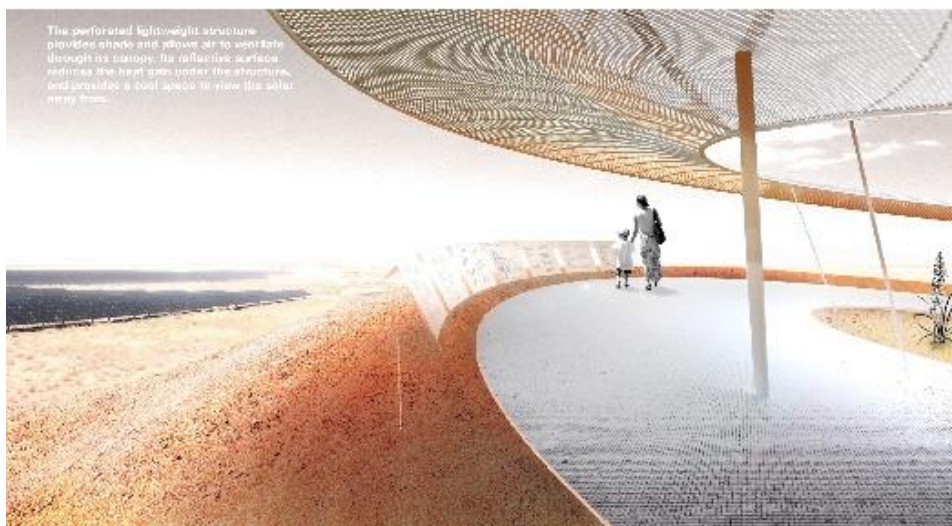
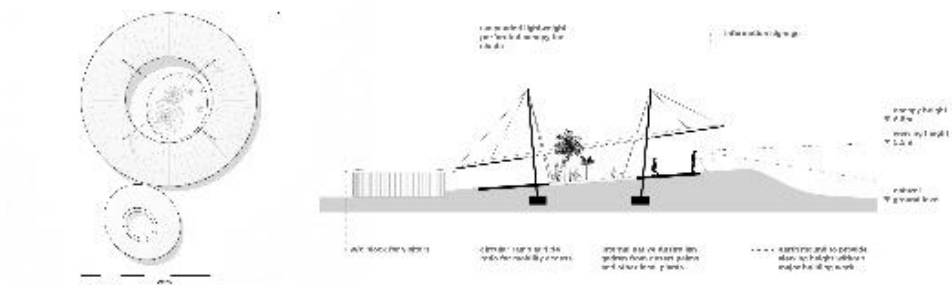

The design superimposes 2 landscape conditions; one, an expansive panorama of the Broken Hill solar farm and the Australian desert, and two, a small introspective garden planted with native desert palms and flowers. These two

'sites', contrast each other. The geographic experience of the Australian desert is amplified, encouraging perception in the viewer, jolting them into a new awareness of the landscape and its production. The sublime technological scale of the solar farm is augmented by the intimacy of the garden.

BIOGRAPHY: Ben Waters is principal of OSK Architects, a young and award winning architecture studio headquartered in Melbourne. He graduated with a Master of Architecture from RMIT University, and studied at Parsons School of Design, New York. In 2014, Ben was awarded a residency position at Berlin's Centre for Art and Urbanistics (ZKU). Ben currently leads a design-research studio at the University of Melbourne, Architecture Department.

CONSTRUCTION:

Structural support made of steel. Roof/ceiling made from colour-bond steel with attached LED strip lights (shining up) covered by opaque Perspex that will make the construction glow at night. (a space between the LED and the Perspex will disperse the light). The railings around the platform will be made out of either wood or steel, the top balustrade will have enough space to attach LED strip lights shining down, with mirrors inserted on the lower balustrade to reflect the light and make the whole railing glow at night. Cut channels in the colour-bond and Perspex will allow for optical prisms to be inserted that will cast an array of rainbow coloured light onto the viewers during sunlight.

DESCRIPTION

I am your futuristic bus stop. Step inside and allow me to transport you into the beauty and wondrous potential of our sun. I will supply you with shelter from the elements while you view the breathtaking display of thousands of energy harvesting solar panels covering the 140 hectares of land before you. I will dazzle you with the colours of the rainbow, generated by the sun and made visible through the optical prisms installed in the ceiling over your head. At night, I will be visible from miles away when my roof and railings illuminate by LED lights powered by the surrounding solar panels, making me glow like a setting sun (or maybe the rising moon) and remind you of the power of our life-giving sun.

BIOGRAPHY

Anna Norstrom is a sculptor/visual artist based in Lismore, northern NSW. She is passionate about the environment and her preferred material is the used and discarded, assembled into something new while reflecting the past. Anna is also interested in the potential of light as a sculptural means and has utilised LED light in some of her former works. Anna gave birth to the original idea of the proposed work in collaboration with Mirko Ritlop and RJ Poole. Mirko is a carpenter/joiner/sculptor based in Tyalgum, northern rivers. Mirko's expertise assisted greatly in the final structure and form of the proposed work as well as in the making of the model. RJ Poole is a photographic artist based in Lismore, northern NSW, his photographic skills as well as his deep knowledge and interest in light were of great assistance when it came to brainstorming ideas as well as the documentation of our proposed work.

36

THE ROTUNDA
STEPHEN WARBURTON

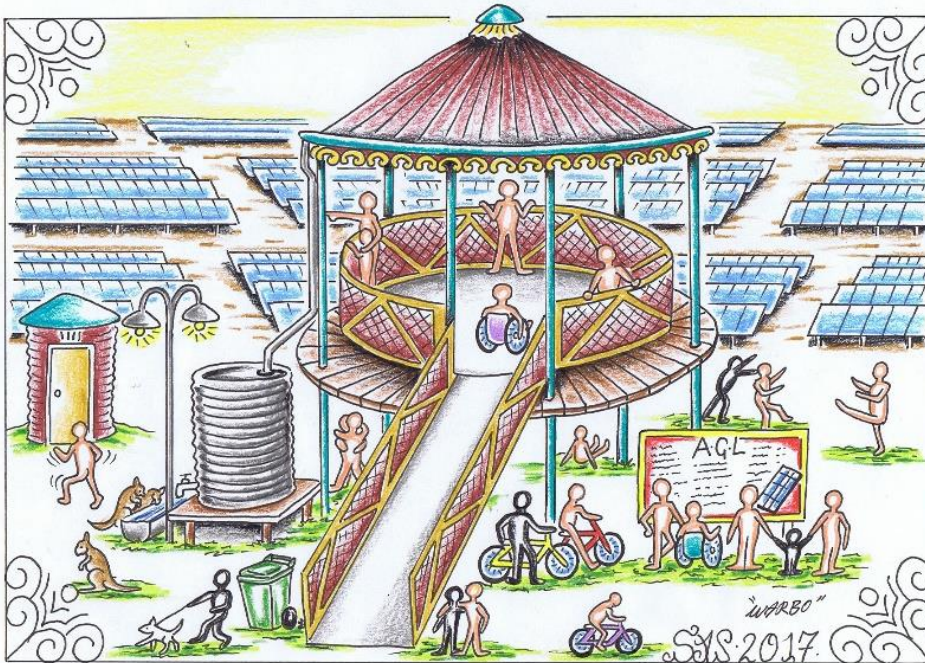

CONSTRUCTION MATERIALS
Steel, iron and concrete

BIOGRAPHY
I'm a 58-year-old male who has been born and bred in Broken Hill, and would love to see more of this innovative construction in the area

37

THE SOLAR WAVE
STEPHEN WARBURTON

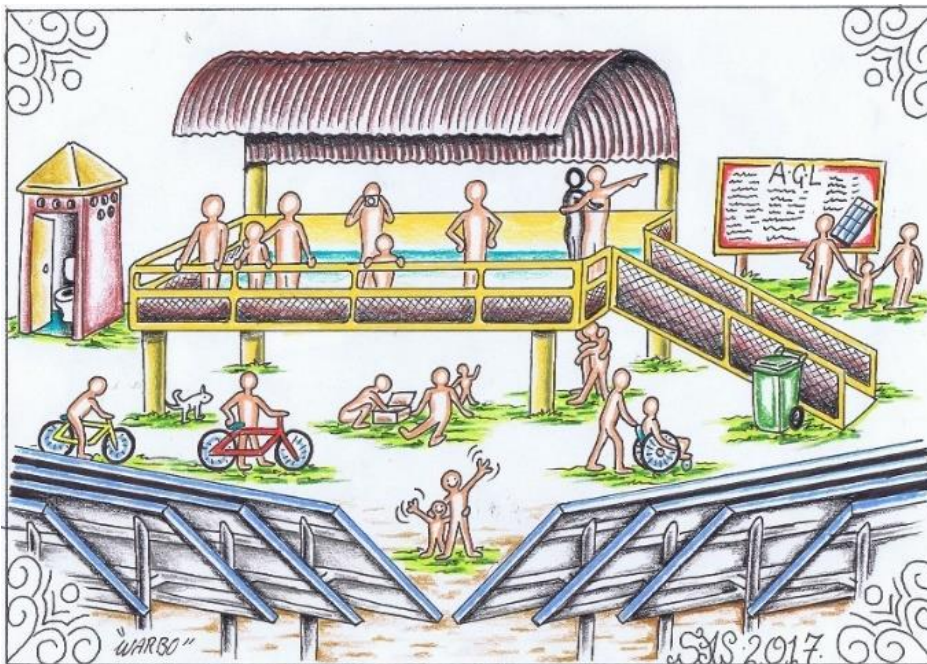

CONSTRUCTION MATERIALS
Steel, iron and mesh

DESCRIPTION
A wave-like veranda.

BIOGRAPHY
I'm a 58-year-old male who has been born and bred in Broken Hill, and would love to see more of this innovative construction in the area

38

THE RAMP
STEPHEN WARBURTON

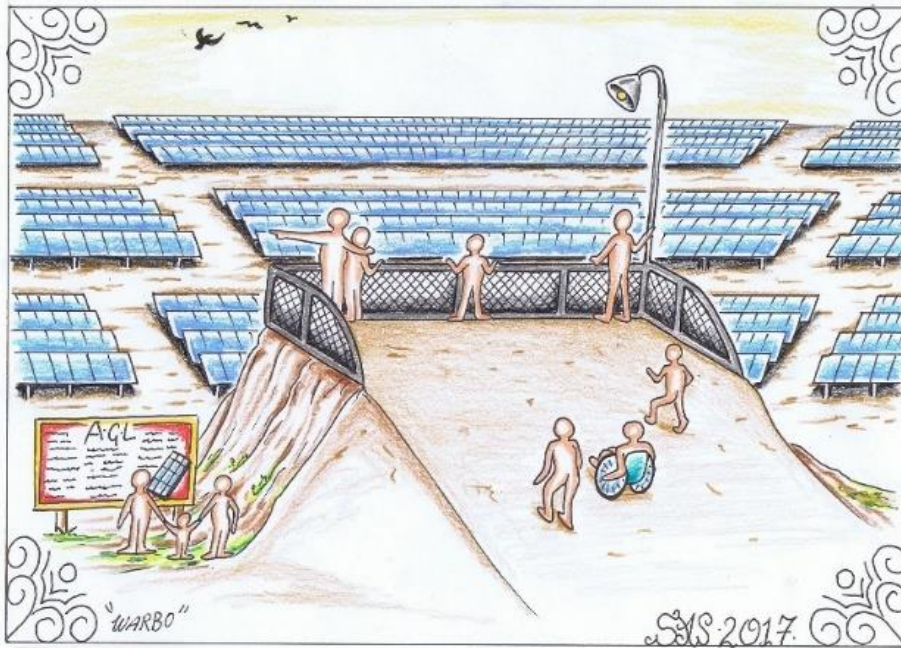

CONSTRUCTION MATERIALS
Dirt and wire mesh fence.

DESCRIPTION
A very cheap option.

BIOGRAPHY
I'm a 58-year-old male who has been born and bred in Broken Kill, and would love to see more of this innovative construction in the area

39

SOUTHERN CROSS SOLAR
VIEWING PLATFORM AND BBQ
AREA
VERONICA GOODLET

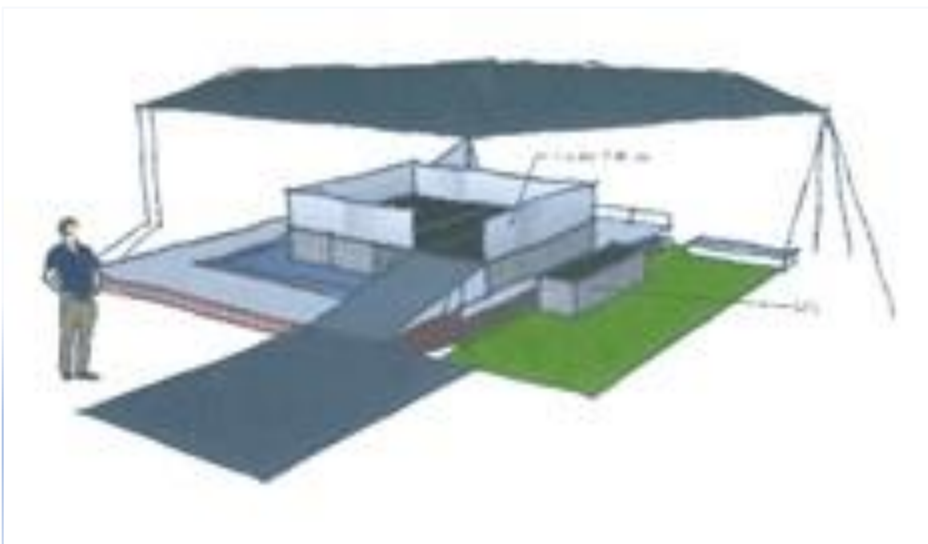

CONSTRUCTION MATERIALS
Steel construction, concrete slabs. Australia manufactures one of if not the best steel in the world and it has a longer life span then wood and minimal maintenance & repair and concrete is hard wearing and low to none maintenance cost.

DESCRIPTION
CYCLE STRUCTURES that form the southern cross 1 OF WHICH ARE VIEWING PLATFORMS UP TO 6 METRES HIGH AND SHADE with ramp cycling to the top of viewing

platform 3 BBQ AREA Powered by Solar panels AND 1 TOILET FACILITIES also powered by solar panels and water from a rain water tank which will also water native plants around viewing area

BIOGRAPHY

Hello, I'm a grandmother to 11 beautiful grandchildren and one on the way. I have lived in many parts of Australia but broken hill has and always will be home.

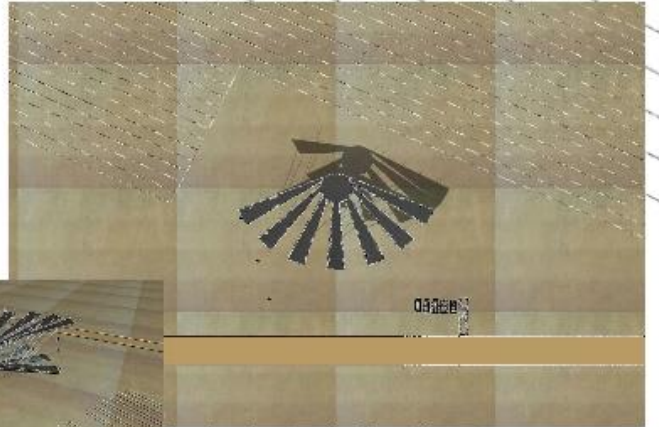
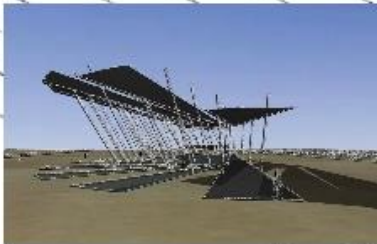
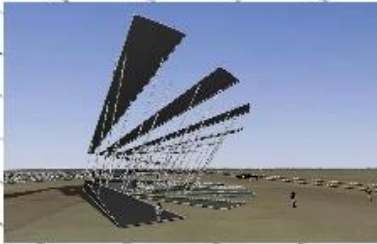

CONSTRUCTION MATERIALS

Steel platform and upper structure and concrete base. A light weight structure but durable in the harsh landscape. Some shallow reflection and convection ponds contribute to the design and experience of the site

DESCRIPTION

The intension is to create a sculptural platform from Which to view the field of solar arrays. The concept is a response to tracking the path of the sun across the array, from rising in the east to the setting in the west. The Title referring to the direction of the sun, travelling across the landscape from the point of the observer and referencing it in the sculptural form of the structure.

BIOGRAPHY

An architectural practice based in the Central west NSW, undertaking public works projects, community initiatives, exploring adaptive reuse of public space informed by sustainable environmental practice.

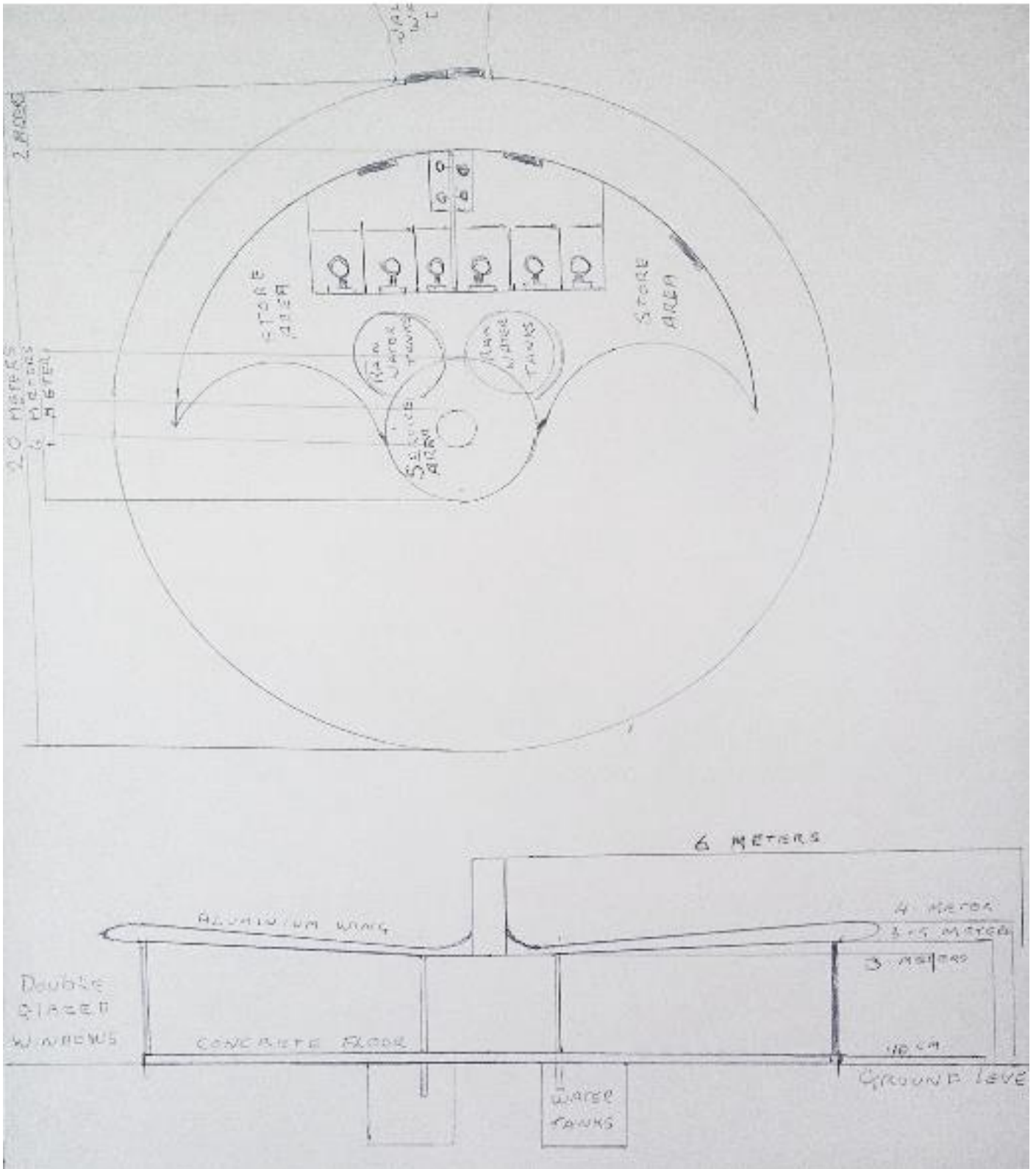

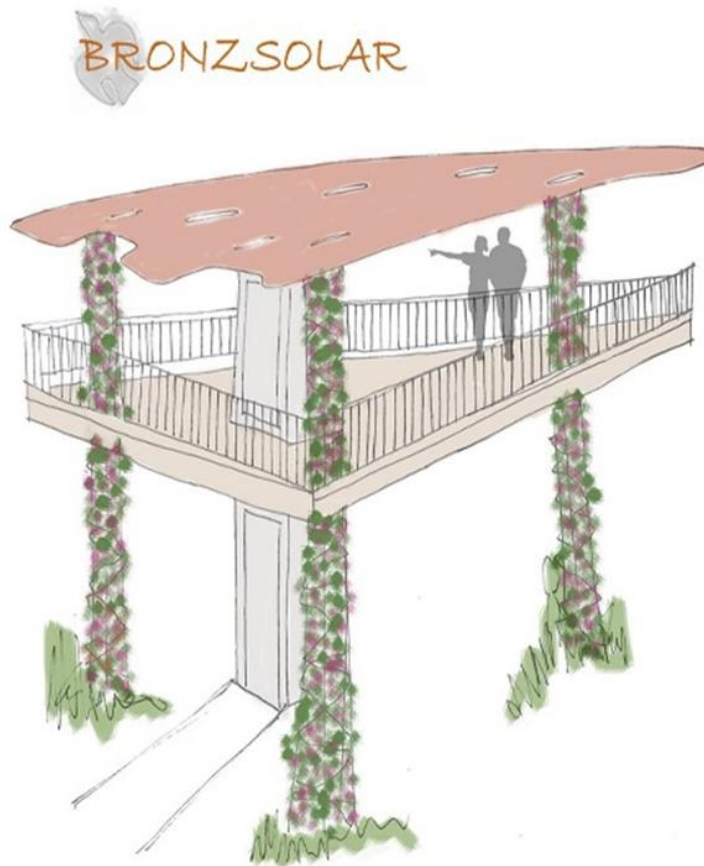
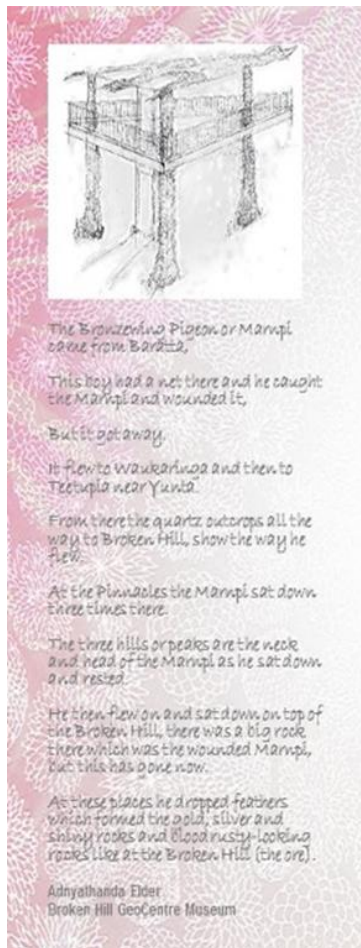

CONSTRUCTION MATERIALS

The floor of the structure would be recycled hardwood, to retain a natural feel but still be environmentally sustainable using recycled materials. Metal frames for the 'Pinnacle' structure with fast growing vines like bougainvillea growing up them.

Timber handrail so it doesn't get too hot and wire balustrades to limit the obstruction to the view while maintaining safety requirements. The roof or Marnpi would be constructed from hardwearing sail cloth to protect viewers from the sun and glare but to avoid heat absorption.

DESCRIPTION

The concept of our design for the AGL Solar Panel Viewing Platform centres around the indigenous Australian Bronze winged pigeon story. The story explains the journey of the injured Marnpi, (pigeon), which lead to the creation of the Pinnacles. The three metal framed columns in the design represent the three pinnacles and the protective roof to the structure represents the soaring Marnpi. The 'Pinnacles' would have vines growing up them to soften the feel of the structure.

BIOGRAPHY: Nicole Dann, Interior Design consultant & teacher; Graham Dann, Building Designer and draftsman, self-employed, Metra Design & Drafting.

CONSTRUCTION MATERIALS

Having researched the shingleback skeleton structure, this would form the basis of the viewing platform. The covering (essential for the climate) would be constructed from strategically placed tile-like 'shingles'. The shingleback skeleton structure forms the basis of the viewing platform, with 'ribs' supporting the sun-protective 'roof' or covering.

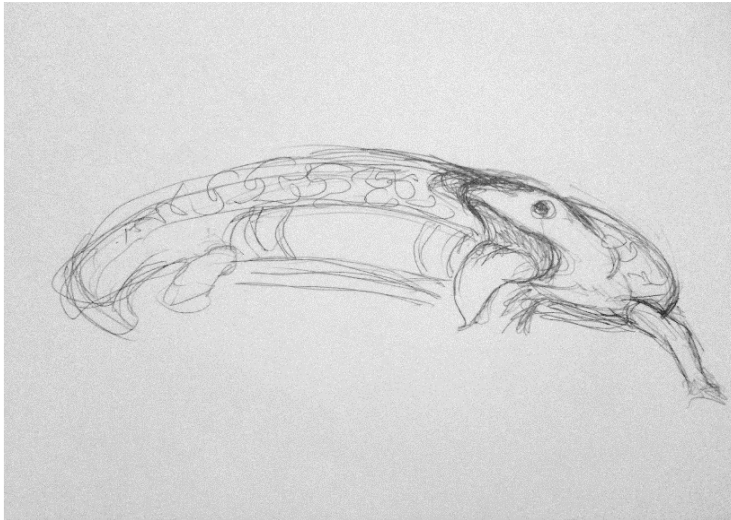

Steel pipe 'ribs' form the shingleback skeleton as this would convey a very strong construction. The inside curve of the 'Shingleback' forms the entry and exit to the platform which is located within the body. The outer curve ribs are the elevated viewing platform, which would give a possible 180-degree view or more.

As I was unable to attend the Solar Farm tour, I visualise that the elevation of the viewing area will be in the form of a mound or berm. Wheelchair/disability access via a series of earth-coloured concrete switchback pathways to the entrance of the structure – similar to the concrete pathways to the Sculpture park atop the Living Desert. Stairs should not be required. Surrounding

the paths, envision low growing shrubs to create a natural bush setting. Arrangement of Shingle roof covering – there are possibilities of using a range of materials. I am unaware of sizes of solar panels available, but it would be a novel and appropriate use and AGL would have access to this information. Alternatively, in keeping with our cultural heritage, a covering of tile-like 'shingles' made from a metal overlaid with a coating of local crushed minerals, courtesy of local mining company/ companies, depending on cost and availability (galena would be perfect, the source would require investigation). The structure will sit within the 20 x 30 metre footprint, and at a height which will comply with creating a safe environment and easy access for a bus load of visitors. A more in-depth drawing/maquette will be provided should there be interest in this concept.

ALISON SUTTON – AGL VIEWING PLATFORM ART & DESIGN
Inspiration – Images not for publication, compliments to the photographers.



DESCRIPTION: Having returned to Broken Hill recently, I wanted to visit the solar farm, so drove out onto the Adelaide road to find the best vantage point for viewing. Being advocates of renewable energy, AGL and I have a common interest... Looking back towards Broken Hill was an awesome sight, the solar farm looking like a large black pool in the desert – I immediately thought of the shingleback lizards which would often crawl across the roadways to and from our fair city. Like the solar panels, the shingleback also absorbs the heat of the sun for energy. Even before the AGL Viewing Platform competition, I

imagined this ancient creature protecting the 'pool'. A sentry visible to all on entering the solar farm. Here, I share my vision.

BIOGRAPHY: I was born and bred in Broken Hill but left 30 years ago, to pursue a life of learning, and also returning a couple of times a year to visit family and friends. Completion of Diploma of Fine Arts – Hunter St Campus Newcastle. Building Better Cities program: Commissions: Steel Weather Vanes (Carrington), Street furniture, frescoes (Carrington), Artists' assistant for various murals located around the Newcastle area. Newcastle Bicentenary – horticulture – public gardens

BIRD'S EYE VIEW

**DESCRIPTION**

From the Barrier Highway, the viewing platform looks like a gigantic emu whose metallic body feathers shine invitingly in the bright sunlight. Visitors will be attracted to the other side of the structure where a glass door will invite them into the cavernous 'body' of the emu, enclosed by glass.

Immediately past the entrance the graduated walkway will lead visitors to the large viewing area. Directly facing the solar plant will be a convenient waist-level bench top on (or under) which to lean, rest small tripods or other items to permit comfortable viewing and photographing. The arrow markings on the surface of the walkway will gently probe visitors to make their way back to the lower level where they will be able to peruse information posters on the supporting columns. A souvenir shop/information desk will be situated below the walkway. While other places in Australia boast their main characteristic with a large structure (the Big Banana, the Big Lobster etc.), it seemed fitting to select an animal that is typical of the Broken Hill region for this project. The emu features prominently in Aboriginal creation stories. Not only does its daytime presence blend in well within the context of sourcing the natural energy of the sun but at night it will provide a reflection of the 'emu in the sky' constellation seen towards the centre of the Milky Way.

CONSTRUCTION MATERIALS

OUTSIDE: a steel cage structure would provide the framework on which to attach aluminium sheets to represent emu feathers. It is expected that the metallic feathers will weather over the years and develop the 'rusty' look that is so typical of the mining town whose power is supplied by the solar farm. The emu head and neck would be a steel and lacquered wood sculpture to be done by an established sculptor.

INSIDE: the symmetry and rigidity of the solar panel would be softened by artwork in the form of mosaic featured here and there on the tiled hebel walls and concrete flooring. Hebel is a high thermal resistance, fire resistant material which will be appropriate for such a construction. The non-slippery graded hardwood walkway would sit on concrete columns and be bordered on its right-hand side by a safety ramp which could feature locally sourced materials. The concrete columns would include both mosaic artwork and information panels about the Broken Hill solar farm and solar energy in general. The glass wall at the front of the building would be made of double-glazed slightly tinted tempered glass for its strength and insulation qualities. The viewing bench, made of mulga wood, would be waist-high and separate viewers from the glass wall so as to avoid damage. No sitting on the bench would be permitted. The building would be brightly lit and air-conditioned.

BIOGRAPHY: Born in Paris, I was surrounded by great art and architecture during my youth but it isn't until my current retirement from a bureaucratic life in a major city that I started discovering the joys of creativity. Living in Broken Hill has provided me with the perfect context for the exploration of different mediums and the expression of my environmental and political stance through art. I am excited by the journey ahead.

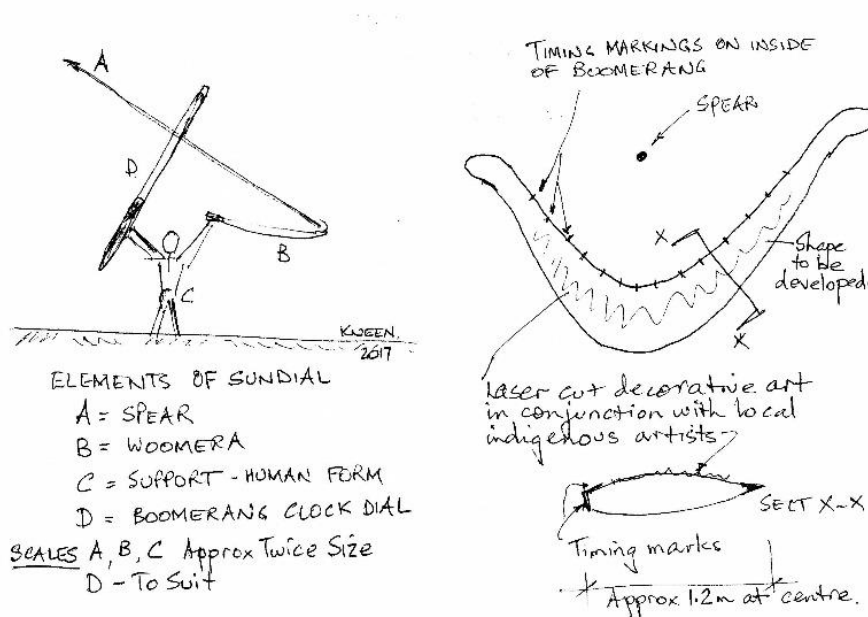

CONSTRUCTION MATERIALS

The preferred scheme would be for an outside "iconic" sculpture where the size of the "human support, woomera and spear" would be about twice real life. The preferred sculpture would be either viewed from the information kiosk or the start of the approach pathway. In this case the best material would be stainless steel with a concrete footing. For a second choice where dimensions were limited then other materials would be considered such as bronze.

DESCRIPTION

The design concept sketches outline a proposed sculpture which incorporates indigenous elements such as a spear, woomera and boomerang into a form that provides a working sundial. Our indigenous people used very little energy for many thousands of years compared to modern day society with its needs for transport, heating and cooling and to power equipment and infrastructure. The sundial reminds us of the passing of time and to utilize renewable sources of energy wherever possible.

The orientation of the spear reflects the angle of the solar panels. The woomera or spear throwing device suggests that we should get the best benefit from our tools. The boomerang, with laser cut decorative artwork and hour time marks would be at right angles to the spear. See attached sketches. [Perhaps the sundial outside St Katherine's Dock near the Tower Bridge in London would give an idea of the size and impact of the proposal. See <http://footprintsoflondon.com/2014/07/our-top-10-london-sundials/> The angles reflect the latitude of London.

BIOGRAPHY

Retired structural engineer – now an artisan and photographer.



CONSTRUCTION MATERIALS

My proposed design predominately features steel framing and steel cladding for its robustness to harsh climates, durable and pre-finished qualities. Fabrication of the building can be undertaken off site and delivered to be assembled on site quickly.

DESCRIPTION

The aerial view of the solar farm is visualized in the landscape as an abstract sculpture; it is this 2D geometry that has influenced the new viewing platforms appearance. The exposed steel frame and angular folded cladding is a contemporary icon that reframes Broken Hill's heritage as a rich mineral mining resource centre and now transitioning to a renewable and sustainable future. The viewing platform sits in the landscape as a sculpture remnant from the movie mad max.

The visitor explores movement by being encouraged up the stairs to an open deck and tiered seating for 50 plus, which looks out over the solar farm. Below the visitor can engage in

interpretive displays where the structure seemingly hangs over to provide shade and shelter from harsh conditions. The deck has spatial provisions for a solar powered lift (subject to available funding), which provides access for disabled. The perforations in the cladding cast patterned light that, celebrates the vision for Broken Hill in responding to the energy needs of the 21st century and the importance of sun light as the source of energy. At night-time visitors experience an illuminated structure from LED lighting powered by the day's solar gain.

BIOGRAPHY: Born and raised in Port Pirie. Moved to Adelaide to study Architecture. Have worked as an Architecture graduate for 12 years and have worked on a number of gateway airport projects across Australia and internationally, I have also worked on many significant defence projects in South Australia and in 2008 was a joint winner of Adelaide's Victoria Square ideas competition in 2008. I am married with two boys and live in Adelaide.

DESCRIPTION: The “SolaVista Lookout” concept is based upon a flat-topped mound with locally sourced rock capping similar in profile to the Mesa and Butte desert landforms found in the Broken Hill region. Atop this mound is a vernacular industrial structure with the essence of the mining pithead, visible from some kilometres. Several laser cut steel art forms adorn this tower. An adjoining deck offers panoramic vistas of the AGL solar farm in its natural environment context. This deck is constructed of recycled banknotes and other plastics and resins in keeping with the green credentials

of this project and the solar industry. A pre-rusted steel shade structure bathes the deck with laser cut leaf pattern dappled shade. Solar powered interpretive signs to the decks stainless steel railing explain the AGL – Broken Hill partnership, Project statistics, and how it is transforming the electricity industry in Australia and the world. Access from the carpark is via a gently sloping ramp suitable for disabled visitors. This path winds up the mound flanked by Sturt Desert Pea plantings radiating like sunbeams from the lookout amidst other endemic plants such as saltbush varieties, assisting in reducing erosion as well as merging this manmade feature into the desert landform.

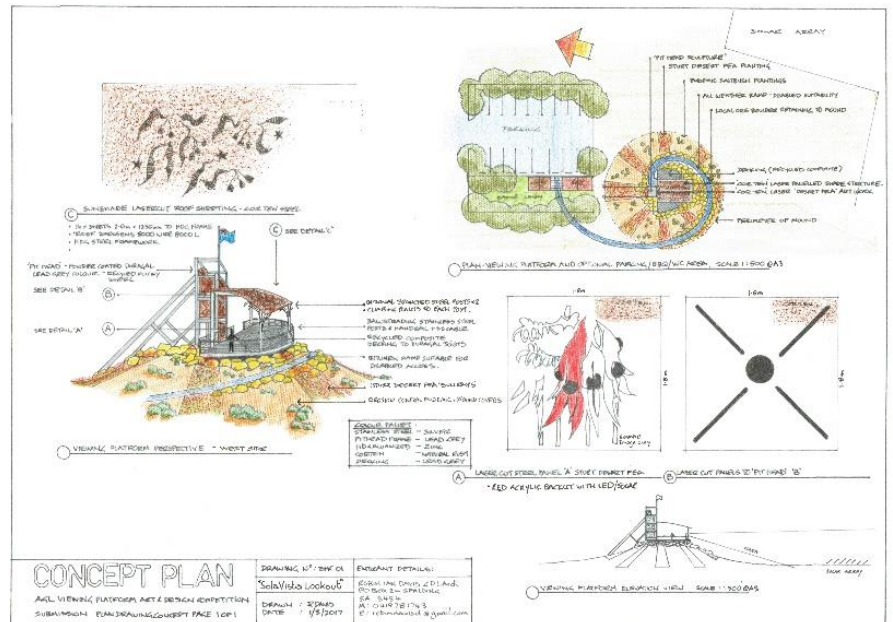

CONSTRUCTION NOTES

The earth mound and rock retaining work locally sourced and on site for logistical and economic reasons as well as topsoil soil compatible with chosen plants. The “pithead” structure from recycled and powder coated steel in keeping with economics, durability and maintenance. A recycled pithead pulley wheel could be left in its natural rusted state. The deck sub structure in zinc coated steel for durability and its connection with zinc mining and BHP. The decking in composite recycled materials for durability, minimal maintenance and fire resistance. Environmental Revegetation grants etc. The deck balustrade in Stainless 316 handrail and cable due to durability, colour reminiscent of Silver (BHP). Art features and shade panels in Cor-ten pre-rusted steel for appearance, ease of laser cutting or waterjet cutting and nil maintenance. Pathway in road base overlaid with bitumen for low glare, high slip-resistance and economics. Plants for stabilizing the mound could be obtained from local growers, or Local Australian Plant Society. The decking in composite recycled materials for durability, minimal maintenance and fire resistance. Environmental Revegetation grants etc. The deck balustrade in Stainless 316 handrail and cable due to durability, colour reminiscent of Silver (BHP). Art features and shade panels in Cor-ten pre-rusted steel for appearance, ease of laser cutting or waterjet cutting and nil maintenance. Pathway in road base overlaid with bitumen for low glare, high slip-resistance and economics. Plants for stabilizing the mound could be obtained from local growers, or Local Australian Plant Society.

BIOGRAPHY: I have a background in Industrial Chemistry as a senior technician in Analytical Chemistry laboratory. Following further studies in Landscape Architecture, I managed a small building company specialising in design and construction of decks, pergolas and home improvements. After a stint in Solar system sales, I worked as a Business Development Manager for a stone products company, and presently own and manage a landscape design consultancy (OLE Outdoor Living and Entertainment) in the mid North of South Australia, specialising in water wise, fire wise, low maintenance gardens for urban and rural farm properties. I am an active member of a

local Australian Native Plant Society, and Water Officer for the local Landcare group. My hobbies include photography, gardening, and travel with my wife.

48

POWDERED WITH STARS
JAMES JONES AND PETRINA
MOORE
(JONES MOORE ARCHITECTURE)

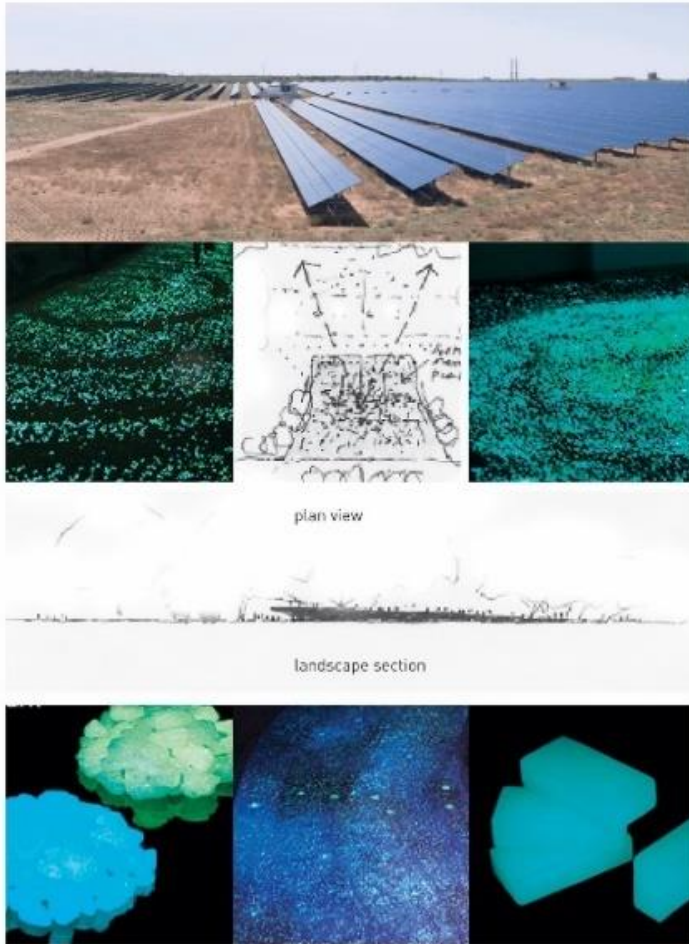

Jones Moore Architecture – AGL Viewing Platform Art & Design Competition Entry
Powdered with Stars:
platform utilising embedded or sculptural light emitting glass (collects, stores & emits light) as celebration of solar energy

CONSTRUCTION MATERIALS: Material definition is to be hard wearing and enduring and could include light emitting glass chips cast in the concrete, timber decking to reduce heat loading, with local materials. Material selection and application would be informed by use, weathering properties, maintenance, longevity, tectonics and cost.

We propose special glass blocks and/or chips that collect, store and emit light (on exposure to short---wavelength light). Our proposal can take the form of a sculptural object, or block, or surface embedded with light emitting glass pieces. In this manner, solar collection will be expressed as a radiant force and form. If chips are used, the platform has the potential to reflect the celestial sky (the sun’s home) – with a powdering of stars that express the diurnal nature of night/day. We would prefer a landscape platform, but emphasise that the proposal will accommodate all forms of construction and materials – relative to practical and feasible implementation of the viewing platform and the brief requirements. Modular panel construction is also possible.

A large ‘tablet’, canted gently to create an inclined plane that rises formally toward the solar array, with light-emitting glass embedded, or arising, could formally and literally engage with the place and enhance the character of a solar collector. The proposition could then become one of holistic place making, a device by which the Broken Hill Solar Plant could then be defined as an optimistic metaphor, rising above the ground plane, defined by a dissolving edge, simple yet powerful, working in daylight and illuminated with renewable energy at night.

DESCRIPTION: As an identifiable landmark/destination – visibly radiating light, symbolising and celebrating renewable solar energy – the Platform will make a positive contribution to Broken Hill as a practical, feasible design that is easily adjusted to preferred requirements/methods of construction. We propose special glass block and/or chips that collect, store and emit light (o exposure to short wavelength light). Our proposal can take the form of a sculptural object, or block, or surface embedded with light emitting glass pieces. In this manner, solar

collection will be expressed as a radiant force and form. If chips are used, the platform has the potential to reflect the celestial sky (the sun's home) with a powdering of stars that express the diurnal nature of night/day. We would prefer a landscape platform, but emphasise that the proposal will accommodate all forms of construction and materials relative to practical and feasible implementation of the viewing platform and the brief requirements. Modular panel construction is also possible. A large 'tablet', canted gently to create an inclined plane that rises formally toward the solar array, with light emitting glass embedded, or arising, could formally and literally engage with the place and enhance the character of a solar collector. The proposition could then become one of holistic placemaking, a device by which the Broken Hill Solar Plant could then be defined as an optimistic metaphor, rising above the ground plane, defined by a dissolving edge, simple yet powerful, working in daylight and illuminated with renewable energy at night.

BIOGRAPHY: James Jones and Petrina Moore of Jones Moore Architecture (JoMo) have worked together on diverse and awarded projects – both small scale and major civic projects in Hobart, Sydney, Melbourne, Brisbane, Adelaide and Canberra. James and Petrina developed the formative ideas and concept framing for GoMA, the acclaimed Queensland Gallery of Modern Art, (Architectus 2001---6), with Lindsay and Kerry Clare, and Geoffrey Way. James won the prestigious Robin Boyd Award for the Trial Bay House 2010 and the National BlueScope Steel Award for the Aurora Energy Operations Centre Jones Moore's recent project experience includes a functional brief for NGV Contemporary and a masterplan study for Heide MOMA and extensive portfolio of experience including civic, education, commercial, judicial, residential and logistics projects.

49

ARCH
RERN SEAN WONG

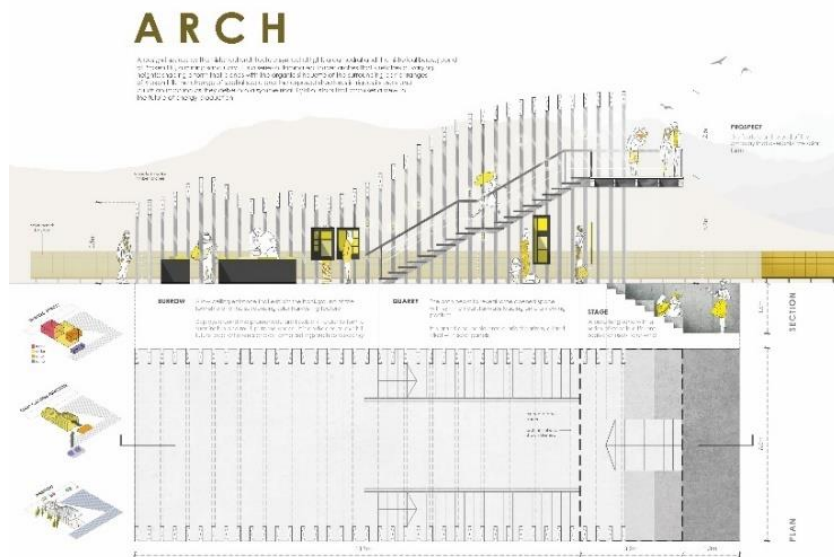

DESCRIPTION: The design is inspired by the historical architecture symbol of light, a cathedral and the historical background of Broken Hill, a mining sanctuary. It is a series of laminated timber arches that stretches at varying heights to form an organic promenade. Additionally, it is an extension to Broken Hill's popular sculptural attractions such as the sculptures in the Living Desert and the Big Bench.

The archway begins with a low height space that has displays to exemplify the background of Broken Hill, AGL and its solar mining activities. The human-scaled atmosphere builds

anticipation and allows its users to experience the tactility of the timber arches. As they burrow further into the promenade, they are impacted with a large tripartite spatial arrangement; two stairways and a central nave that leads out towards the solar farm. This arrangement is inspired by the historic planning of a church; two side aisles and a central nave that is grand and floods the building with light.

Ultimately, the aim of the design is to compliment the sustainable intentions of the solar farm while also promoting the tourism sector of Broken Hill. It is imagined to be flexible and allows the exhibition to be interchangeable. The accessible promenade also allows the space to be used for event such as wedding ceremonies or other social celebrations. It is an inverse concept of mining; it points its users upwards towards the sky to find prospects rather than unearthing.

CONSTRUCTION: The material of choice would most definitely be timber, specifically a series of cross laminated timber arches with horizontal bracings. As it is exposed throughout the day, it is important to choose a material that does not overheat. Not only that timber is a very sustainable material, it has a low thermal mass which makes the archway approachable for any season. Although timber requires treatment, a simple coating system would allow the design to be maintained well and it would only need to be observed or reapplied every couple of years. The foundation for the sculpture on the other hand would be in concrete in order to provide a decent blend between the primary timber structures at a cheap cost.

BIOGRAPHY: Originally from Malaysia, I migrated to Australia 7 years ago, for my tertiary studies in architecture. I lived in Tasmania for the first three years while I was studying my bachelor degree. Here, I cultivated my interest in environmental designs and have been attempting to merge my designs with a hint of sustainability ever since. Furthermore, I am also interested in interchangeable and flexible designs that are able to deliver multiple uses in a single space.

Currently, I am a practicing graduate architect in Sydney, specialized in multi-use high rise residential designs. At the moment, I work predominantly in the construction fragment in architecture. During my leisure, I enjoy learning more about architecture history because I believe that they provide us with a peculiar understanding of nature and proportion. It is a rare notion that is often overlooked and is slowly fading away in contemporary design.

Personality wise, I see myself as a charismatic and friendly young man that is always up for a chat. I love exploring nature and capture moments in a still art forms such as photography or sketches

**50 PAVILION OF THE SUN
BROC WEBSTER**

CONSTRUCTION MATERIALS

The material making up the main body of the structure should have the quality of being stone-like in texture and warm in tone, connecting it to the earth and giving it weight and integrity. While solid sandstone would be difficult to use given budget restraints, a similar effect may be achieved with less expense if stone or concrete cladding was fixed to an internal framework. This would give structural integrity while maintaining the illusion of a solid stone structure.



The awning projecting above the viewing deck could be constructed with corrugated iron, a classic material associated with Broken Hill and significant to the history of BHP steel. The blue tone of the steel would complement the warmth of the stone, and over time would gain a patina to further harmonise the building with the earth. The water feature and lower half of the access ramp may be able to be constructed by paving over compressed earth in the same material used for the cladding to create a seamless link between the free-standing structure and the base while avoiding the need for a frame throughout the whole structure. Polished brass panels

may fit the purpose of reflecting light towards approaching visitors and adding a golden sheen to the rear side of the structure.

DESCRIPTION: Shining like a beacon on the horizon, embedded with reflective panels that glint gold as they catch the sunlight upon approach, the *Pavilion of the Sun* marks Broken Hill's transition from the *Silver City* to the *City of Gold*. Conceived as being a location of solar reverence, it acknowledges the eminence of the sun as a source of great energy by honouring the architectural qualities of historic sun-worshipping cultures. A shallow pool surrounding the entire structure reflects the heavens, ensuring that the presence of the sun is always felt regardless of where it is positioned in the sky. The trapezoidal silhouette of the pavilion is a remote echo of the iconic mullock heap that is the heart of Broken Hill. A wide base tapering towards its apex, its shape is endemic to the desert landscape, where the mounding of earth through natural and manmade forces coupled with entropy creates distinct rising features that seemingly slide downwards into the flat plains. The slope of the sides are designed to minimise shadows cast outside the structure while maximising the shaded area on the inside of the back wall, where the information panels are situated. The entrance way, being reminiscent of mining supports, leads visitors on a symbolic journey through a darkened subterranean space and out into the sunlight, creating an experience evocative of the progression from Broken Hill's history of mining the earth to its future; mining the sun.

BIOGRAPHY: Broc Webster holds a degree in fine arts from the University of New South Wales. He achieved class 1 honours and received the University medal for fine arts in 2014. Working between the mediums of traditional painting, digital imaging, photography and sculpture, Broc is currently a practising artist located in Wollongong, NSW. Broc has family heritage in Broken Hill that dates back several generations.

51 **THE SEEDLING**
BADEN CORR



"The Seedling, in honour of its name, is a platform to celebrate Broken Hill's 130 years of mineral mining and the current transition to mining the sun. This solar installation is a seedling in Australia's energy resourcing future."

CONSTRUCTION MATERIALS
Old mining shed: Roof – Corrugated Iron, Walls – Brick construction (thermal properties) and corrugated iron cladding. Solar PV roof: Roof – Weatherproof blue board, Seedling – Steel construction. Concrete Slab Floor – Polished concrete (low maintenance)

DESCRIPTION
The Seedling, in honour of its name, is a platform which celebrates Broken Hills 130 years of mineral mining and the current transition to mining the sun.

"Exhibition quality"

A mammoth 310 m² of sparkling polished concrete flooring adequately provides accommodation for over 50 people.

The flow of visitors is managed with large dedicated entry and exit disabled access ramps.

One will enter The Seedling experiencing the historical non-renewable mining methods before leaving packed with knowledge about Australia's future in energy resources - The Sun.

"Architectural excellence"

The Seedling exemplifies all aspects of quality design. It has an abundance in shade for visitors, great cross flow ventilation, aesthetically complements the landscape and optimises visitors viewing direction of the solar installation.

The Seedling will become an iconic "must see" when visiting the Broken Hill community.

"Smart, practical, feasible"

The use of durable and robust materials such as polished concrete, brick and iron ensures The Seedling has an extensive life with very little maintenance.

The smart simple design provides a space that brilliantly serves its design intent, is able to promote the history of the Broken Hill area and be built within the clients budget.

This move is a stepping stone, a seedling, in Australia's growing push to harvest renewable energies. At the centre of the design a seedling has sprouted and grown to support a solar photovoltaic panel.

BIOGRAPHY

I am a graduate consulting engineer in the Building Services department. I have a large interest in building design and developing structures that strongly meet their use intent.

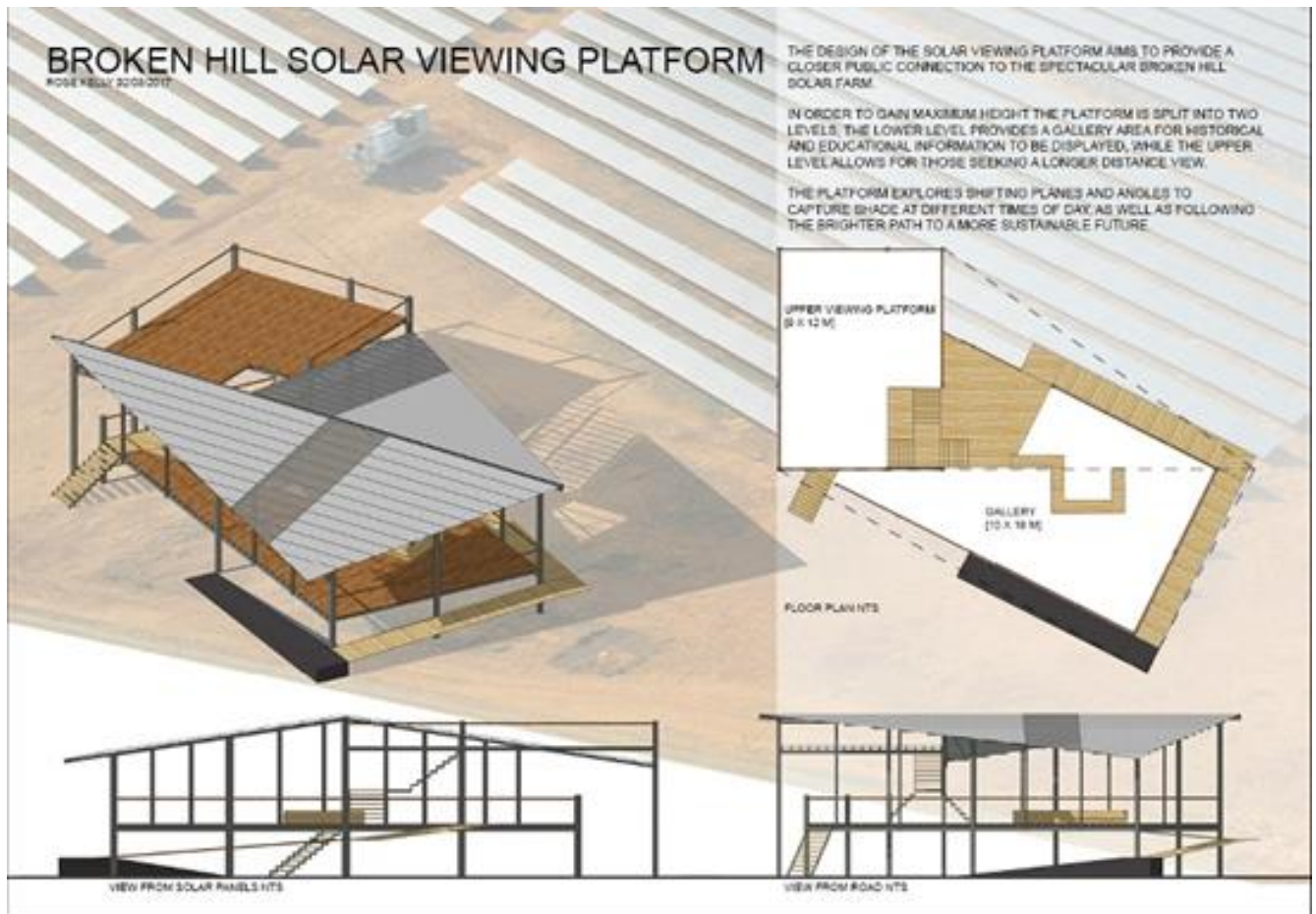

CONSTRUCTION MATERIALS

The materials envisaged for the design are light weight and sustainable to accompany the strong environmental message of renewable energy given from the solar panels. The framing is all in steel to protect from rusting and termites, and the topping is all in hardwood timber to give of sense of softness to the structure. The roof to the lower level is half custom orb roof sheeting and half polycarbonate to provide extra light.

DESCRIPTION: The design of the solar viewing platform aims to provide a closer public connection to the spectacular broken hill solar farm. In order to gain maximum height, the platform is split into two levels, the lower level provides a gallery area for historical and educational information to be displayed, while the upper level allows for those seeking a longer distance view. The platform explores shifting planes and angles to capture shade at different times of day, as well as following the brighter path to a more sustainable future.

BIOGRAPHY: I am a recent graduate of architecture and am working with troppo architects, I am very interested in sustainable design and creating spaces to accommodate peoples' needs. I am currently working in Darwin but normally am based in Adelaide.

DESCRIPTION

Broken Hill's solar array represents the future of both technology and innovation for rural communities across outback Australia. By drawing upon the notional 'futuristic' nature of the program, this elevated platform seeks to provide a glimpse of tomorrow by utilizing new material applications and processes that align to AGL's mission to test and commercialise models for new energy technologies.

CONSTRUCTION MATERIALS

By using computer aided design and building integrated technologies, the structure is made from a thermoformed glass skin that is to be prefabricated off-site and installed to create as little disturbance to the natural surroundings as possible. The integration of landscaping to the viewing platform re-establishes the link between the look-out and the local flora with native flowers and grasses creating an elevated natural setting.

Including a mirror-like thermoformed glass skin, the concept responds to its context by enhancing the view of the natural environment, creating a look-out that is in balance with the site while promoting its significant innovation for energy production in Australia. In contrast to the detailed grain of Broken Hill's local artistic heritage, this elevated look-out seeks to reference the lustre and reflectivity of the metals on which the area was established. Through this lens, the look-out becomes not only an architectural asset for tourism but a significant marker for the bright future of Broken Hill and its reputation for innovation.

**BIOGRAPHY**

We are a collective team of architects and designers working across various design practices in Brisbane, Australia. We are a collaborative team bringing together our combined skills and experience to work on designs that excite and challenge us outside of our 9 - 5 day jobs.



DESCRIPTION: Responding to Broken Hill's natural surroundings, the 'Embedded Out-look' draws upon both Cultural and Environmental cues from the local area and community. Drawing from the rich history of mining, the concept seeks to use both metal and earth to create a responsive structure that is sympathetic to the area. With elevation created through the mounding of earth, a natural formed elevated platform is both sustainable and cost effective to construct.

The connection and subsequent celebration of the renewable energy created by the solar array and the environmentally responsive outlook concept demonstrates the progressive and innovative foundation of the solar program.

CONSTRUCTION MATERIALS

By using locally sourced and readily available materials, the feasibility of the project is established with local business having significant involvement in the fabrication of the design. Further to the sustainable precedent that this project sets, it's greatest asset to the community is through establishing a place not only to view the great accomplishment of such an innovation in solar technology, but a recognition of sustainable building practices that set the basis for innovation across the country.

By using local materials (red earth and corten steel) and responding to the natural environment, the project aims to utilise sustainable design practices such as: thermal mass, orientation and natural ventilation to become a leader in innovative and sustainable building practices. The decision to embed the tower in the landscape by mounding the existing earth was made to create a breezeway from the visitor drop-off zone to the viewing deck. A moment of delight is discovered as the visitors' journey through the space defined by corten steel panels etched with information lining the passageway; the path opens to frame the vast solar array in focus

BIOGRAPHY: We are a collective team of architects and designers working across various design practices in Brisbane, Australia. We are a collaborative team bringing together our combined skills and experience to work on designs that excite and challenge us outside of our 9 - 5 day jobs.

**CONSTRUCTION MATERIALS**

The structure would be constructed out of brick made with rammed earth, keeping the natural red ochre, with a slurry of earth render. This is a way of building that has existed for centuries and still continues with the Acoma community of New Mexico, where the buildings have stood for 800 years. This style of building used to make the viewing platform would appear to mould and shape the surroundings that is desert and would look significantly different from the solar panel fields. The structure is

low maintenance and a natural insulator, the brick bottom of the spiral could be a room to get out of the direct sun and become an information resource. The structure being a continuous ramp makes it accessible to everyone.

DESCRIPTION: My interpretation for constructing a viewing platform is inspired by American Sculpture Robert Smithson's "Spiral Jetty" built on the edge of the Great Salt Lakes in Utah, U.S. This was constructed out of mud and rocks and embraced the entropic nature of land art projects of the 1970's. My proposal for a "Solar Spiral" would create an object of beauty that is both experiential and versatile. Walking a circular climb to the top of the spiral reveals a 360-degree view. The base of the spiral structure could be an information/education room for visitors to find further information on the Solar Farm and future projects. It will embrace the environmental concerns and aesthetics that created the "Land Art" movement of the 20th Century, like using raw building materials such as local rock and rammed earth brick. Yet it would embody a 21st ideology of conservation, preservation, alternative energy and keeping fossil fuels in the ground.

BIOGRAPHY: Carla Cescon lives and works in Sydney Australia. As a visual artist, her focus is sculpture and drawing. Artist run initiatives have been a passion for Carla and she has been involved with several such as the Institute of Contemporary Art Newtown, Loose Collective and 55 Gallery Sydenham. Carla has initiated and directed special arts programs for people living with a disability, resulting in public art projects in Ashfield and Summer Hill. Her exhibition history is long and highlights have been group shows at Edia House New York U.S, Hamish McKay Gallery Wellington N.Z and Artspace Sydney A.U. She has been represented by Scott Donovan Gallery Sydney AU, Michael Lett Gallery, Auckland N.Z. Carla is currently working on a new series of work that involves sculptural interpretations of early natural Histories drawings of animals and plants.

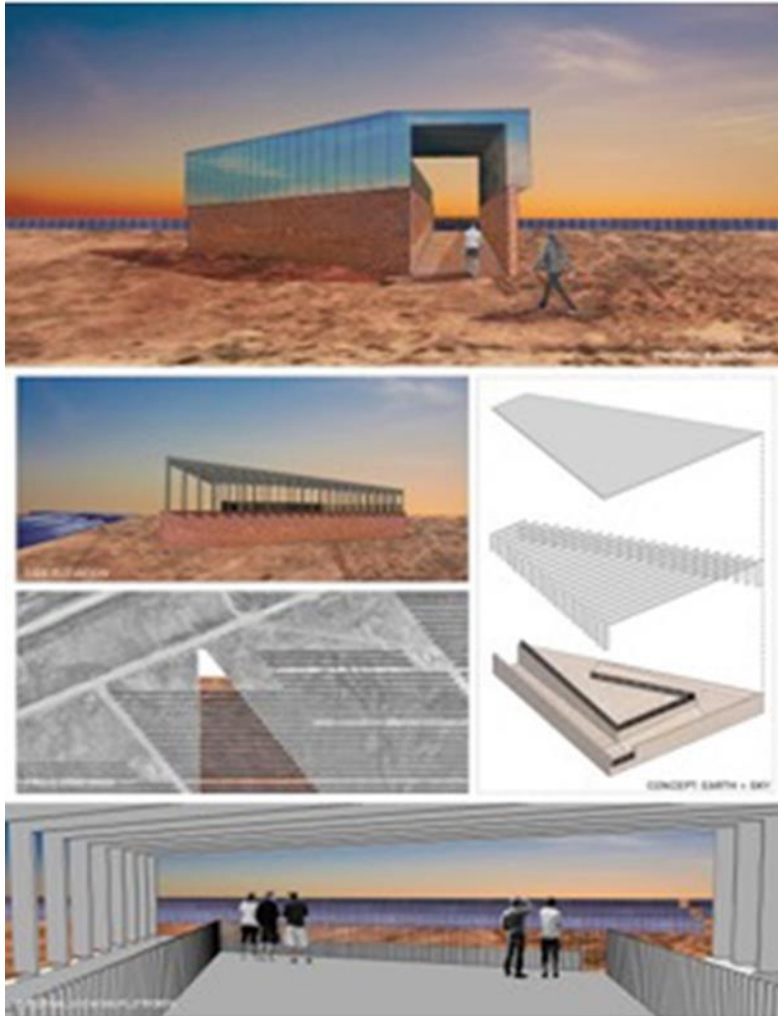
**CONSTRUCTION MATERIALS**

The main construction materials would include:

- Rammed earth foundation— the benefits of this include its superior thermal mass, temperature control, strength, durability and low maintenance, fire proofing, load bearing, and pest deterrence. Also, it has strong aesthetic beauty and connects to place blending with the colours of its surrounding landscape. Further, as it is a natural material and environmentally beneficial, it would be highly desirable from a sustainability perspective.
- Reflective mirrored façade – Enables the external environment to be mirrored and giving a strong connection to its surroundings. It provides shade and its innovative design will allow ventilation flow. Also, a reference to Broken Hill as the ‘silver city’. This could be made from a type of composite cladding/aluminium panel with a lightweight core. Benefits include highly corrosion and weather resistance, low weight, fire proof, unbreakable/strong construction, low environmental impact, long term performance, anti-graffiti coating, suitable for public art.

DESCRIPTION: The design of my Viewing Platform is based on the concept of earth and sky. Both the earth and the sky are natural elements that can create energy. The structure represents the earth as Broken Hill’s heritage as a rich mining community; and the sky as the possibility of transitioning to an enlightened future. My design begins with a foundation of rammed red earth, sourced locally, thus creating a strong connection to the landscape and demonstrating sustainable environmental practices. This foundation builds, through a ramped pathway, opening up at an elevated platform which celebrates the sky from many different viewing experiences and focuses its dominant view towards the solar installation. The 7 signs @1mx1m can be accommodated on the rammed earth walls commencing at the entrance to the pavilion. The viewer, moving through the space, experiences a connection to the earth, the innovative presence of the solar installation, and then elevation to the sky. The rammed earth foundation is shaded by a reflective mirrored façade and roof structure which from a distance, will fade into the landscape. The deep mirrored facade shades the internal spaces while minimally obstructing the view and allowing natural ventilation. Within the structure, the dynamic façade will produce an ever-changing interplay of light and shadow as a poetic notion of sunlight. The overall form privileges the triangular space made available within the solar array. It expands outwards towards the view both in plan and elevation to maximise the viewing experience of the solar farm.

BIOGRAPHY: I am Timothy Bauer, a Student Architect with a passion for creating environmentally sensitive buildings that have strong, innovative and dynamic design, connecting people to place. I have a Bachelor of Architectural

Design from the University of Queensland, 2016 where I was recognised as a Birrell Scholar and awarded 2nd place for the Centor Prize in Design that connects people to the world outside. To develop my interest in critical design thinking and sustainability, in 2015 I completed a semester at the University of California, Berkeley, College of Environmental Design. Further, in 2016 I received a New Colombo Mobility Plan scholarship to study architectural conservation practices in Penang’s world heritage area. I was also a member of a small team that won first place in the SONA SuperStudio (Queensland) team design competition. I am currently working with Hassell Studio Brisbane as a student architect where I am encouraged to develop my design philosophy through their commitment to buildings and places that allow people to feel and experience a sense of meaning, connection and belonging. I am also a member of the creative collective, Five Mile Radius which is an architectural studio that aspires to experiment with building using simple materials from ethical origins. I have grown up in a creative family with a strong commitment to the arts. I am looking forward to continuing this family tradition through my own exploration of art, design and community. I have a deep passion for art and design that intrinsically connects with the land and tells a story about the place and its people.

57 - FINALIST

THE BRONZE WING BRYCE BESSELL



CONSTRUCTION

MATERIALS:

Colourbond Roofing (downpipes and gutters) – Colour Monument – To blend in with the solar panels from above, cost effective and has a life span of 20 plus years, very suitable for the climate.

Kliplok cladding – Colour White – Cost effective material that brings great aesthetic features and longevity, also very suitable for the climate.

Structural Steel (Purlins, Framing, Trusses) – Ensures a projects longevity and will work well within the Broken Hill Climate

Timber Decking – Suitable for the climate, cost effective and little to no maintenance.

Concrete Ramp – Cost effective as a result of reduced structure through having mounding, longevity in the climate and no maintenance required.

DESCRIPTION: A succinct, simple cantilevered architectural solution with a dramatic tapered skillion roof angling up toward the Hills shaped like the Marnpi, expressing favourable aspects of the solar farm and the landscape beyond. The project gains its impetus and visual impact by expressing its structural language derived from deconstructing the solar panel and reconstructing them in a metaphorical manor that extenuates the natural beauty of the farm. Spreading into two main wings much like the Bronzewing, the viewing platform allows for all angles of its surroundings to be seen permitting tourist and Broken Hill citizens to embrace a new culture that has rapidly grown in the area. A sloping berm much like the Bronzewing taking flight, hides a compliant ramp creating a visually pleasing aesthetic that fits seamlessly in to its environment acting as an extension of the ground plane. Moving with the flow of traffic the sloping berm leads the user to the peak viewing standpoints in each wing to take in the enormity of the farm and beauty of the Marnpi hills. Interactive technology and signage is implemented at points throughout the journey to create an engaging and informative experience for all age demographics that visit to enjoy. The Bronzewing scheme presents as not only a symbol for the solar farm but a symbol for the community.

BIOGRAPHY: Recent graduate of Architecture and ex-local of Broken Hill. Growing up in Broken Hill for nineteen years allowed my passion for design to grow and flourish, from living and observing a unique climate and environment to viewing bespoke art forms such as the line of load. Growing up in the country has given me an appreciation in the finite details in life, using this experience I hope to design with great intent to create spaces for people that will benefit from them and their community by bringing them together to celebrate the towns culture and create new cultures.

58

SOLAR TOWER ILARI SEITSONEN

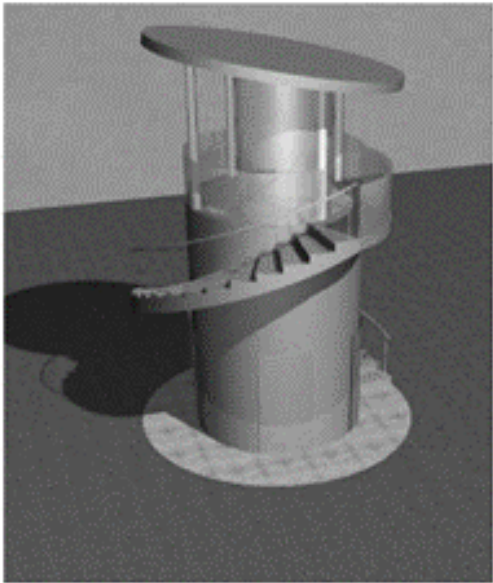

SOLAR TOWER, BROKEN HILL, 2ND MARCH -17, is

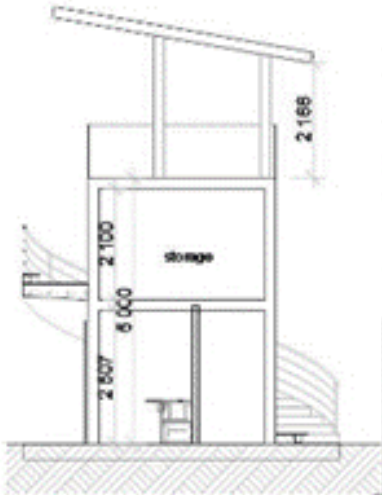

- SIMPLE CONSTRUCTION
- LIGHT WEIGHT ROOF
- 1,2 M STAIRS
- SOLAR PANELS ON ROOF
- CORTEN STEEL OR CONCRETE FACADE
- GLASS RAILING AND ELEVATOR TOWER

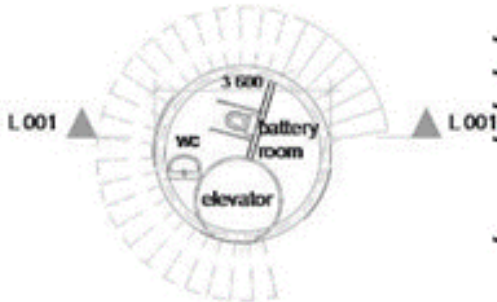
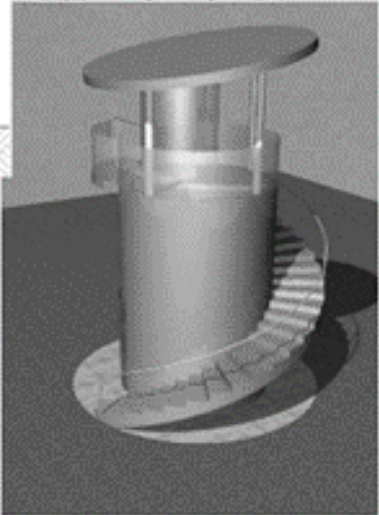

- BASIC FACILITIES
- HANDICAP TOILET
- SIMPLE ELEVATOR
- BATTERY ROOM FOR POSSIBLE ENERGY STORAGE
- 1ST FLOOR STORAGE AREA (WATER?)

DESCRIPTION

A simple tower, on the ground floor: toilet, elevator and battery room for restoring solar energy, on the second floor: storage space. Spiral stairs to lookout level, with glass or steel handrails

CONSTRUCTION MATERIALS

Tower wall construction could be steel (corten) or raw concrete, stainless steel stairs and roofing and on the roof photovoltaic panels

BIOGRAPHY

I am engineer and architect, specialised in energy efficient housing and renewable energy (in Finland).

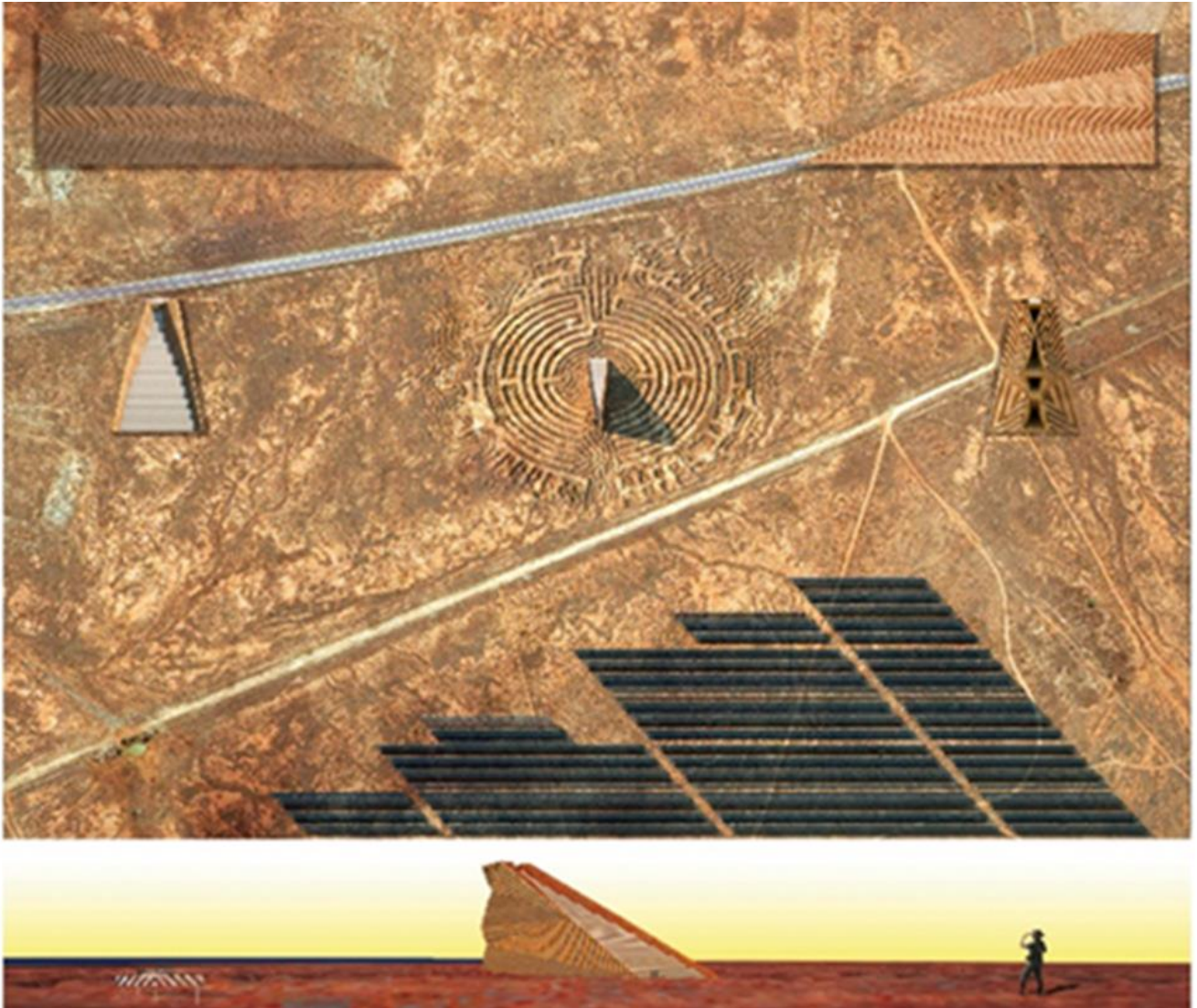

DESCRIPTION

The act of focused observation elevates the merely infrastructural to something which we must give more thought. Ancient spiritual places were a type of infrastructure, ensuring a fruitful society through careful practice of ritual. They facilitated a consideration of our role within the world and an appreciation that we play a role larger than ourselves. These lessons of the past have been brought to this project, which acts as a timely reminder for us to consider more strongly energy generation and the landscape which it sits against.

The act of observation is given a professional quality as you proceed through an earthen mound labyrinth, which acts as a strange marker in the landscape to the satellite viewer. The tower itself is a grand and long tapering stairway, giving this outlook a significance that might otherwise be left forgotten.

CONSTRUCTION MATERIALS

Corten Steel Cladding, Stone Steps, Dirt & Rock landscaping, chosen to impress a permanence and an object which is of the landscape in colour and tone but simultaneously strange, definitively human and mysterious.

BIOGRAPHY: Boyd Mockridge is a graduate of architecture.

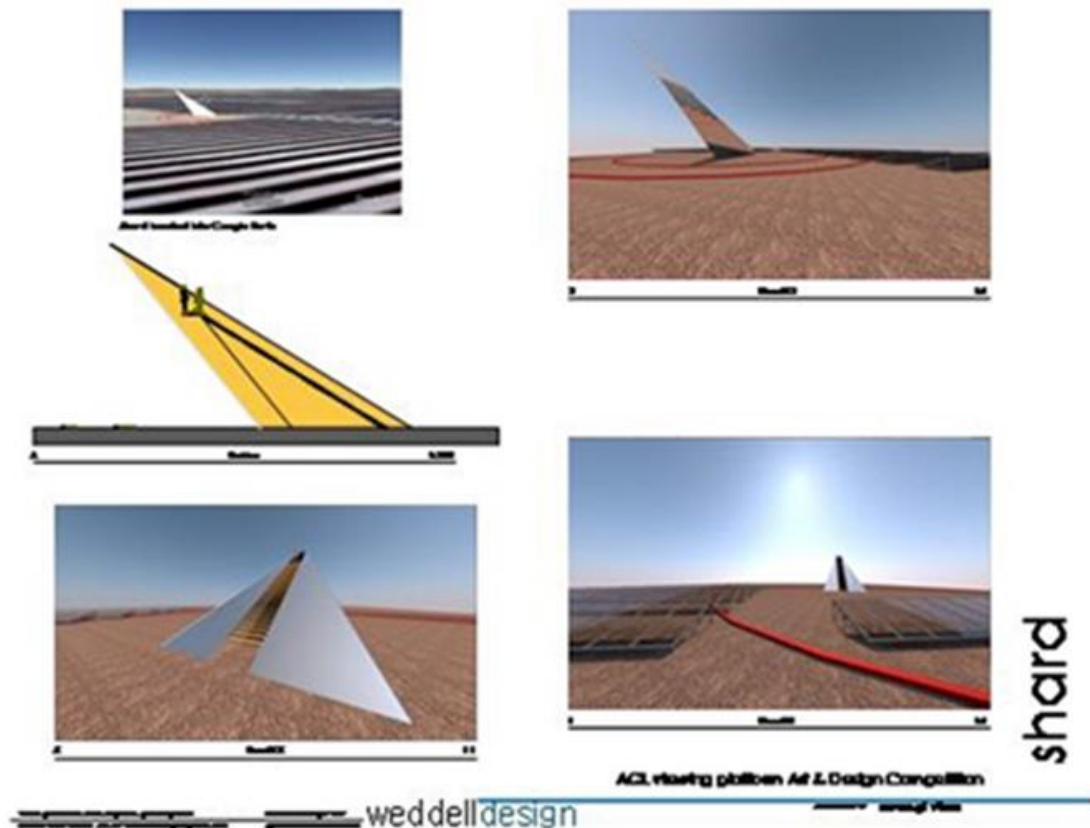

DESCRIPTION

The Shard is conceptualised from the sun dial. As both the sun dial and solar power generation are confined to the same constraints- sun. My initial minds-eye concept was to have the Shard operate as a working sun dial with large numbered sculptures (seat size) on the ground which visitors can see to the only visual result in the both objects-shadow. The red rings in my images would be the intended area required. This combined with a web-site/app which visitors can see live power information from the solar farm. Therefore, as dawn, dusk and atmosphere change they can see the results, if the care too! Alas, the selected platform positions don't allow for the optimum orientation for a sun dial; can that be reconsidered?

CONSTRUCTION MATERIALS

Steel frame wrapped in gold mirrored glass. The glass would be similar to the top section the Eureka Tower in Melbourne. Steel industrial steps leads to the platform. The numbered sun dial seats would be carved from stone-metal would be a little hot! Stone type- TBC

BIOGRAPHY

I'm a registered building design and graduate of Architecture who has work in the field for 17 years with experience in residential, commercial and institutional sectors. I try to incorporate some element of the surrounding environment into my designs that results in some interesting forms. My passion however is for sculpture, particularly large scale pieces. I did one year of a visual Art degree immediately following secondary school (unfortunately not completed); in recent years that urge to create in this field has returned. Presently I'm interested in steel and glass. Pieces include illuminated glass rock (100-400 molten glass) in gabion cages for my nature strip retaining wall, wheat stalk inspired steel kinetic spinning thing to silhouette flat steel plate image of my partner sunbaking (which I move around the garden).

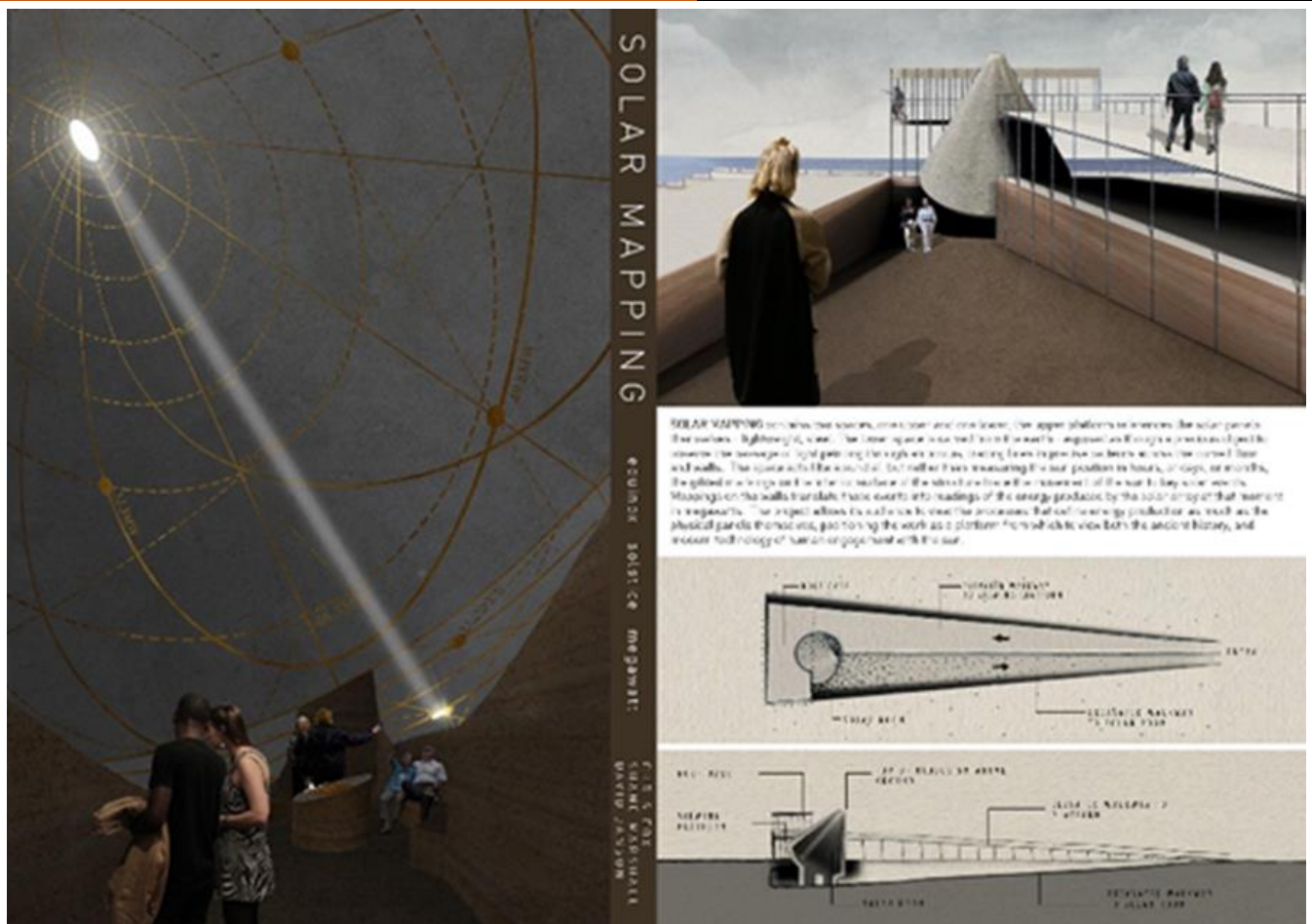

CONSTRUCTION MATERIALS

Our project reads as both 'of the past' and 'of the future' at once. The visitor is presented with a choice: to follow the excavated path through the earth down to an ancient, almost celestial, experience of the sun formed with a mixture of rammed earth and concrete, or to take the elevated path up to the viewing platform which is formed by an efficient steel frame to match the very nature of the solar array in the landscape.

DESCRIPTION

SOLAR MAPPING proposes an underground solar room which the viewer may enter to observe the passage of light as it pierces through an oculus and traces lines in precise patterns across the curved floor and walls. Scientific in nature, the sun room draws its origins from the sun dial, however rather than measuring the sun position in hours, or days, or months, the gilded markings on the interior surface of the structure trace the movement of the sun to key solar events such as equinox, and solstices.

The mappings on the floor and walls translate these events into readings of the energy produced by the solar array at that moment, inscribing these figures onto this solar 'map' in megawatts. The project allows its audience to view the processes that define energy production as much as the physical panels themselves, positioning the work as a platform from which to view both the ancient history, and modern technology of human engagement with the sun.

BIOGRAPHY: A multi-disciplinary collaboration between Artist Chris Fox, and Architects Shane Marshall and David Janson, this team has maintained a strong working association both professionally and academically for over 5 years.

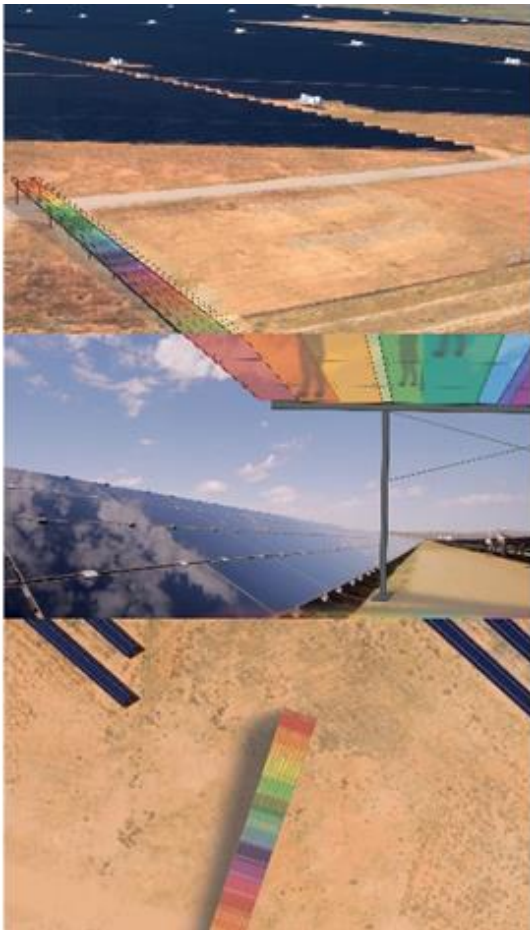

CONSTRUCTION MATERIALS: Chromatic Grid is conceived of as a walkway with a glass floor supported by a lightweight steel structure designed to touch the earth as lightly as possible. The use of steel is an acknowledgement of the origins of the steel industry in Broken Hill and the significance of the industry for the community. Two layers of glass form the floor of the walkway. Each panel of glass is a different colour according to the chromatic scale. The top layer of glass is regularly spaced to create an even surface for walking upon. The bottom layer of glass is irregularly spaced to break up the regularity of the top layer and create a dynamic colour-mixing experience. The glass is acid-etched with detailed grid patterns to increase the visual richness of the glass panels and to create a non-slip surface. A slender steel handrail prevents falls from the walkway with minimal visual intrusion.

DESCRIPTION: Chromatic Grid is a bold, linear gesture in the arid landscape. It investigates the idea of the 'grid' as a geometric ordering device and as a system of dissemination. It responds to the scale and extremity of the solar farm landscape by acting as a lens through which to view it, to consider its significance in our terms of sustainable energy futures, and to experience its spatial qualities in the particular landscape of Broken Hill.

Chromatic Grid is an inclined walkway that offers a gradual approach to the view of the solar farm. In celebration of the solar light that enables the production of energy, coloured glass panels overlap in varying grid structures to create a dynamic colour-mixing experience that is experienced through walking. Looking down whilst moving along the walkway, the ground beneath is viewed through changing planes of colour that animate the earth with respect to individual experience. Colour configurations are dependent upon individual gait, height and pace and focal distance, enabling a personal and reflective consideration of the environment and what it means to draw energy from it. Similarly, moving along the ground beneath the walkway and looking up through it, the sky is viewed through changing planes of colour that in turn invite an analogous consideration of the atmosphere. The geometry of the walkway grid is informed by the geometry of the solar farm layout and the by the solar panels themselves. Detailed grid patterns are acid-etched into the glass to provide a non-slip surface, making the walkway an all-weather experience that is equally accessible to all.

BIOGRAPHY: Ainslie Murray is an interdisciplinary artist, architect and academic based in the Architecture Discipline in the Faculty of the Built Environment at the University of New South Wales in Sydney, Australia. Her work explores the augmentation of architectural space through subtle realisations of forgotten and intangible spatial forces. The atmosphere and its relation to the lived experience are areas of special interest which have focussed her practice-led research for over 15 years. Ainslie's work ranges from large-scale immersive installations and constructions, to film, painting, textiles and printed works. Ainslie's principal interest is in forms of space-making that often escape attention, including ephemeral, minimal and immaterial forms of architecture. She makes work that investigates these forms of architecture in relation to climate, ecology and energy and frequently works in an interdisciplinary and collaborative mode. Ainslie was awarded her PhD in Visual Arts from Sydney College of the Arts, University of Sydney, in 2011. She has lived in Adelaide, London and Munich and is now based in Sydney. Her work has been exhibited throughout Australia and internationally in Canada, China, Denmark, Japan and the UK.

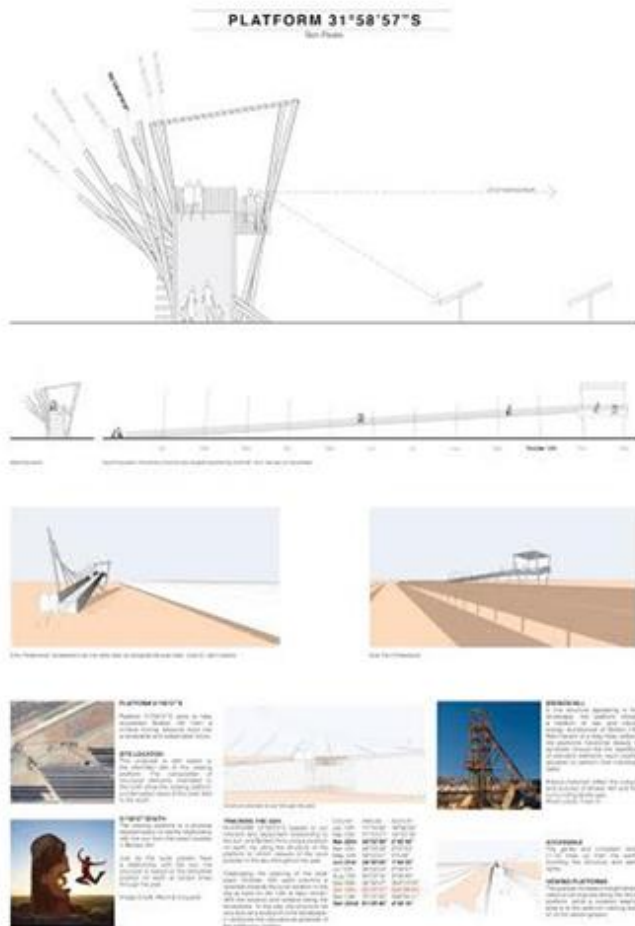

CONSTRUCTION MATERIALS: Broken Hill is filled with past and present steel industrial structures.

A robust material, from the earth, the structural properties of steel allow the platform to be constructed of lightweight materials, reducing shadow impact over the solar farm and providing a low maintenance structure.

A flexible structure, steel will allow the platform columns to reflect the sun's position in the sky throughout the year.

PLATFORM 31°58'57" S is approximately 2.7m x 87m. This is outside the 20m x 30m suggested site area, but has the benefit of a fully accessible ramp, multiple viewing spaces, and less overall area.

DESCRIPTION: PLATFORM 31°58'57" S aims to help re-position Broken Hill from a mineral mining resource town into a renewable and sustainable future by celebrating solar and by creating a new attraction – the AGL Solar Plant Viewing Platform. PLATFORM 31°58'57" S speaks to our inherent and dependent relationship to the sun, and Broken Hill's unique position on earth, by using the structure of the platform to inform viewers of the sun's position in the sky throughout the year.

Celebrating the opening of the solar plant, October 12th, each column is directed towards the sun's location in the sky at noon on the 12th of each month. With the equinox and solstice being the exceptions. In this way, the structure not only acts as a sculpture in the landscape, it reinforces the educational potential of the platform to visitors.

BROKEN HILL: A fine structure appearing in the landscape, the platform follows a tradition of raw and robust energy architecture of Broken Hill. Reminiscent of a slag heap artefact, the platform's functional beauty is achieved through the repetition of standard elements, each slightly adjusted to perform their individual tasks. Robust materials reflect the colours and textures of Broken Hill and the surrounding landscape.

ACCESSIBLE: The gentle and compliant ramp (1:14) rises up from the earth, touching the structure and earth lightly.

VIEWING PLATFORMS: The gradual increase in height allows views to be enjoyed along the entire platform, while a covered seating area is at the optimum viewing level of +5.5m above ground.

BIOGRAPHY: Ben Peake is a Graduate of Architecture, and fell in love with Broken Hill the first time he visited his partner's family. Ben missed the solar plant's opening day by a matter of months, but it was on the list of places to visit on his most recent trip. Previously, Ben has had his artwork collaboration 'Coast Totems' featured in the Sydney Sculptures by the Sea. Coast Totems saw the creative use of mirror polished stainless steel to reflect a distorted image and encourage viewers to re-engage with their surroundings. Ben currently lives in Sydney and works as an architectural designer.



CONSTRUCTION MATERIALS

To promote sustainability and respond to the site, BASK utilises repurposed shipping containers to form the core of the structure. As well as a call back to Broken Hills rich mining heritage, repurposed containers provided an economical and practical solution to the constraints of the site. A unique building medium, containers proved both structure and elevation, adding to the designs focus on the surrounding landscape and views of the solar arrays. Combined with concrete preformed and cast slabs, the containers, glass fixtures and timber highlights work to form a contemporary aesthetic, which highlights both the forward-thinking nature of the Broken Hill Solar Project, and responds to the environmental constraints of the local climate.

DESCRIPTION: BASK is a response to both site and purpose; a structure designed with the experience and engagement of the audience at the forefront. The project focuses on delivering a valuable user experience through carefully considered signage and guiding architectural elements. The detailed design focuses on leading the visitors through the structures and informational destinations, while defining the narrative journey which culminates on the upper viewing platform overlooking the solar arrays.

From the overarching flow of the structure, to the custom sheet metal educational signs, BASK has been extensively detailed to educate and engage visitors. Key points of interest have been explored, encouraging viewers to interact with the site and reflect on their surroundings, as well as the significance of the solar projects as a whole. To capture the scale of the solar arrays and surrounding landscape, BASK was designed to both elevate viewers, and blend with the surrounding environment. Rising from the existing terrain, three areas of elevation are utilised, establishing three distinct viewing outlooks; the enclosed lower hallway, amenities and

outdoor area, the indoor viewing blind, and the uppermost rooftop viewpoint. Landscaping has been used to blend the structure into the existing site, resulting in a hierarchy of objects emerging from its surrounds.

BIOGRAPHY: The team behind BASK is made up of two multi-disciplinary, Brisbane based, design students; David Chapman and Dylan Sheppard. With a broad range of combined experiences working in product design, the automotive industry, furniture and interiors, user experience, and service design, the team thrives on approaching complex problems and working to creating meaningful experiences through detailed design. The Broken Hill Solar Project provided an opportunity for the young designers to step outside their comfort zone and engage with a unique brief. Exploring new challenges in architectural practice provided an opportunity to develop a holistic design solution, which still retained the highly-detailed traits of the team’s day to day work in the field of product design.

65

NATURES REFLECTIONS KUMARI MIDDLETON

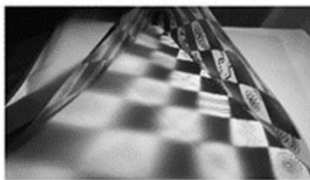
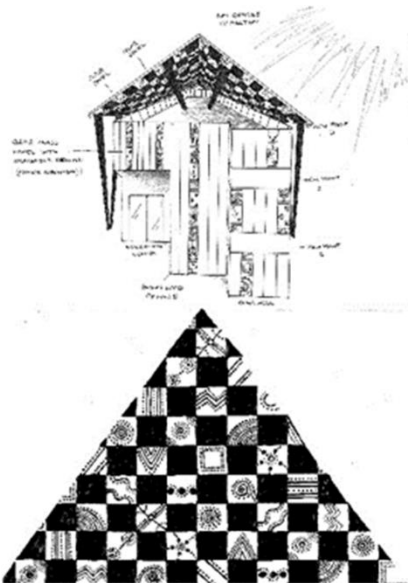

CONSTRUCTION MATERIALS: Wooden Exterior, Glass panels with Indigenous Art, Concrete for viewing area and Steel rods from roof panels to ground.

DESCRIPTION: This is designed to reflect the sun’s rays through glass panels of Indigenous Arts, onto the viewing platform as an education tool about solar generation. The Education Centre’s exterior is brown wood to keep with surrounding colours of nature, with glass panels throughout feature Indigenous Artwork. These have orange highlights to also blend with the surrounding area, these panels will be visually appealing both from the outside and the inside.

The top has a floating roof which is chequered with solar panels and artwork. When the sun is shining, the designs will reflect onto the viewing area ground. * Please note I am not an Indigenous Artist, should this design make it to finals a local artist would be commissioned.

BIOGRAPHY: I am passionate about community arts. I am a Youth Settlement Worker for newly arrived refugees, and deliver numerous dance/ literacy through arts initiative. I also run an International community arts organisation which uses dance to engage with at risk young people. I am a henna tattoo artist, and have recently started small ETSY business selling glassware which I have hand painted henna designs onto. I draw inspiration from this work/ creative process to create this design.

66

SOLAR WALK
MEGAN CUMMING

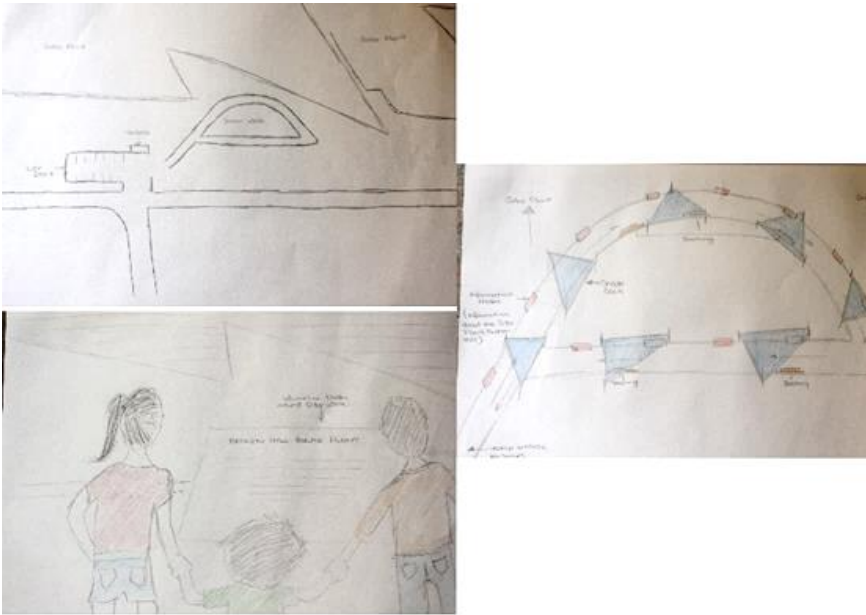

CONSTRUCTION MATERIALS

Concrete and steel. Concrete for the flooring and the same coloured steel for the sides as used at The Line of Lode. I would use these materials as they can withstand all weather conditions.

DESCRIPTION: The walkway is completely self-sustainable. No need for extra staff.

BIOGRAPHY: Moved to Broken Hill 3 years ago, with my husband. Looking forward to starting a family here in this beautiful town.

67

WORLD'S TALLEST SUNDIAL
MITCHELL GORDON
AND CAMERON GORDON

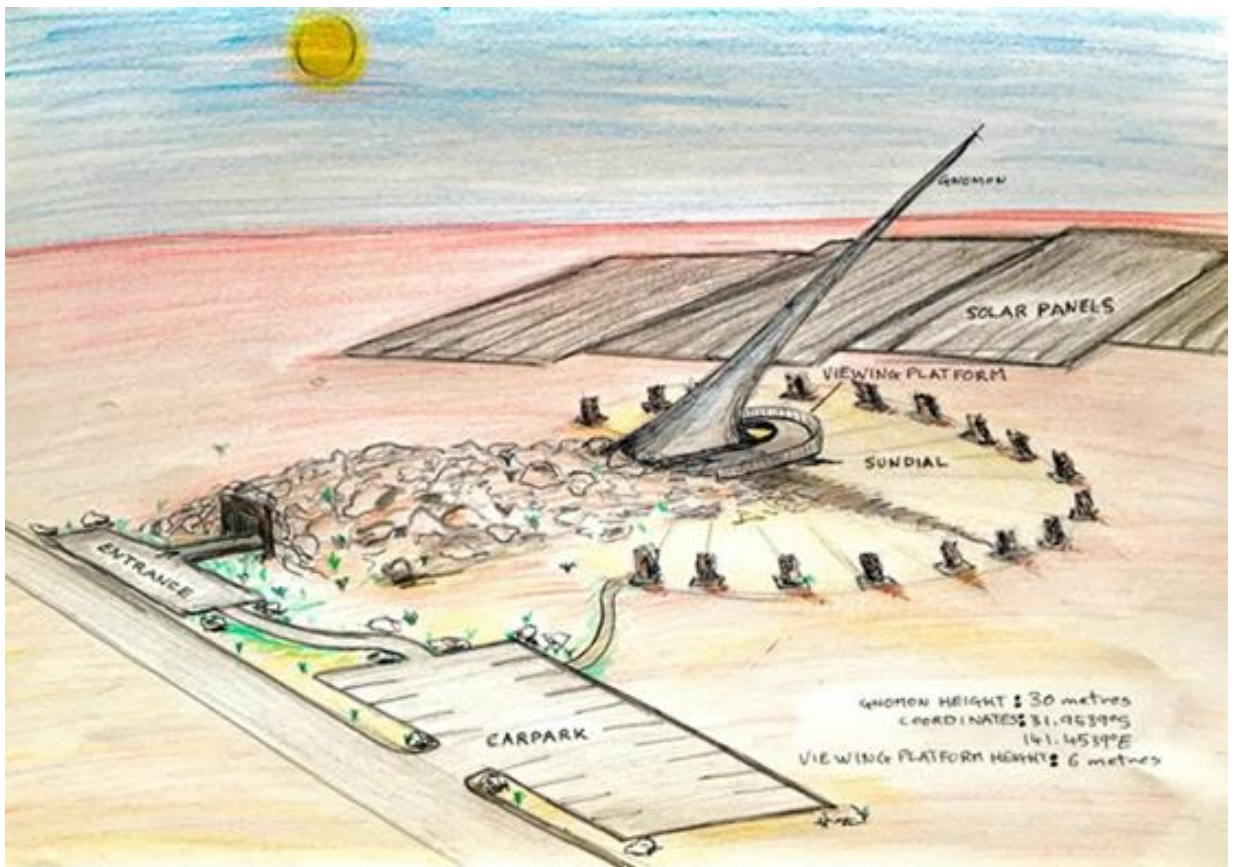

CONSTRUCTION MATERIALS

- Simulated Mine = earthy, rocky materials
- Ramp and viewing platform floor = recycled materials
- Gnomon = mild steel internal structure clad with a highly polished metallic cladding.
- Sundial = natural earth, concrete radials rock monoliths, plants

VISION: To build the world's tallest and most elegant sundial that connects our primal sunlit history via the platform to a vista over the power source of the future.

- INSPIRATIONS:
- Absolute continuum of the sun's light and energy throughout human history
 - Purity of form embracing the purity of the sun's energy
 - Clean, sustainable technology.
 - The contrast of a massive shiny spire emerging out from the red desert.
 - A mining community – The Silver City

KEY ELEMENTS:

- Through the entrance from the car park that looks like an old-fashioned mine shaft entrance.
- Into a manmade tunnel covered by rocks and earth that looks and feels like an old mine.
- Tunnel to show the journey of the human quest for sustainable power. (Interactive/interpretive displays, photos, tangible models etc. How a power station, solar panel, LED light etc. works.)
- Emerge from the mine, darker times, out into the brilliant sunlit future of solar power. The 6m high viewing platform curves around the world's tallest sundial standing at 30m giving a full panorama of the solar array.
- Look down at the desert sculpture garden/sundial with monoliths at each hour
- Stroll down the other side of the ramp to walk amongst the monoliths and feel the shadow and check the time

BENEFITS:

- It will become a significant tourist attraction for the region as it will be the world's tallest sundial at 30m.
- AGL will have a stunning, shining, structure that will show case their sustainable, technology achievements in a physical form for many of their customers.

EXTRA IDEAS:

- Massive stone obelisks (relates to mining culture of Broken Hill) that let light thru only at the 4 solstices as per Stonehenge. A special pagan tourist attraction....
- Solar panels on the hour marking monoliths so when shadow comes over the power output goes down and this is shown on some digital display

BIOGRAPHY: Mitchell Gordon – Chemical engineer, Inventor, Mining Industry, lover of silent technology and red dirt. Cameron Gordon – Sculptor, Creative Project Manager, lover of shiny surfaces.

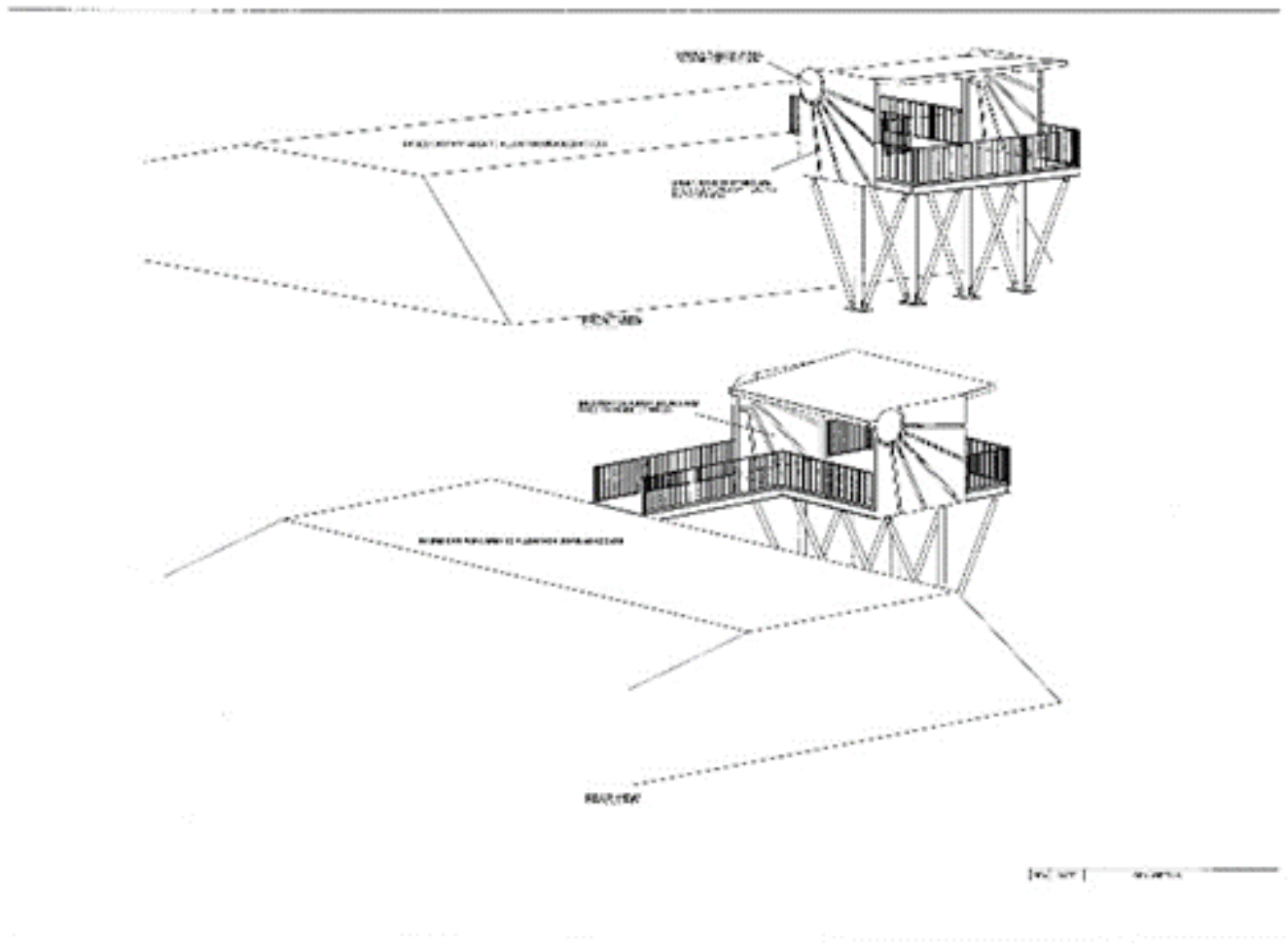

CONSTRUCTION MATERIALS: Steel for the platform shelter itself with a timber decking. The reason for this is so that the structure is durable and not easily damaged by weather or person. The decking would be timber so as not to create reflective heat.

DESCRIPTION: The idea of the work is to create a raised platform with easy access for the disabled. The format of the platform is that it will provide a symbolic face of the sun sending its rays to earth that allows the creation of “green energy”.

BIOGRAPHY: I have lived in Glen Innes NSW for close to thirty years and worked as a draughtsman. During this time, I have designed many projects of varying sizes. I see Green Energy as a way for the future and believe projects such as this are valuable not only to the region in which they are constructed but also to our nation and the planet.

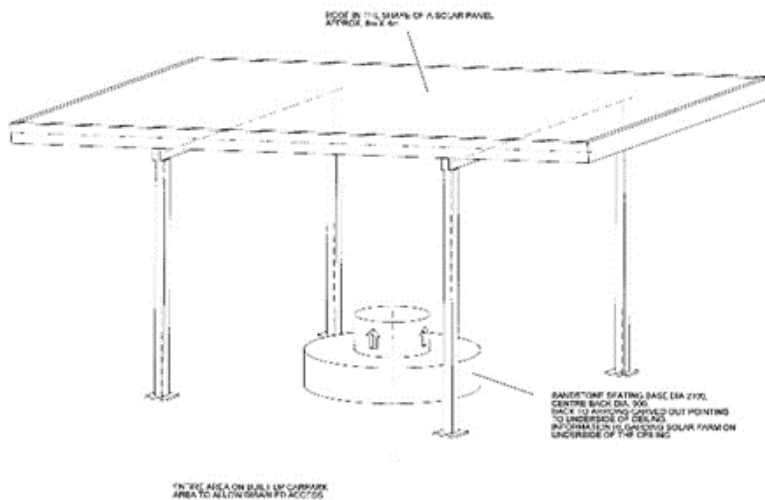

CONSTRUCTION MATERIALS

Steel construction would be the preferred choice of the main structure. The seating underneath would be sandstone or similar stone that could not be easily damaged.

DESCRIPTION

The idea of this work is to create a raised area where a large symbolic panel can be placed. This is to have a seat placed under it with arrows pointing up to the ceiling. The idea behind this is to symbolize looking up to the heavens where the sun is located. Information regarding the solar farm could be placed on the ceiling.

BIOGRAPHY

I have lived in Glen Innes NSW for close to thirty years and worked as a draughtsman. During this time, I have designed many projects of varying sizes. I see Green Energy as a way for the future and believe projects such as this are valuable not only to the region in which they are constructed but also to our nation and the planet.

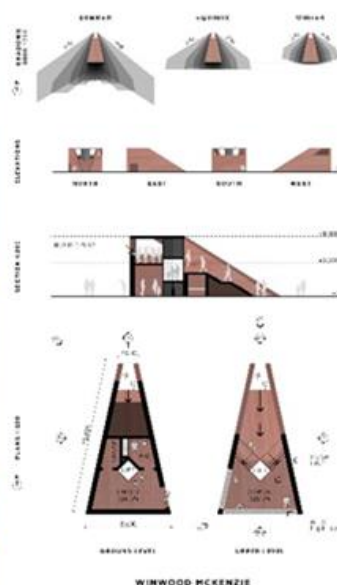

DESCRIPTION: Our proposed viewing platform is inspired by the Wurdi Youang rocks, an ancient aboriginal sundial, the natural geology and history of the region and looks towards the sun and the future. A bold geometrical form of rammed earth with a central staircase is created to be clearly visible and legible in the vast landscape. Rising from the earth the massive materiality contrasts the sunlight and technology being viewed. The shadow cast by the form transforms the viewing platform into a large

sundial expressing the role the sun has played in the history of humanity whilst looking forward to celebrate the sustainable technology of the future. Unlike thinner structures created with lighter materials that would be less apparent in the landscape and require more maintenance the bold form will be clearly legible, low maintenance and durable. A small lift has been added to provide access to the viewing area instead of a long and potentially more expensive ramp. A toilet has also been added as a possible addition to the brief due to the number of the potential visitors and scale of the plant. The design uses resourceful and efficient means to achieve a dramatic result and has been designed with budget in mind. Appearing as an abstract piece of land art our proposed viewing platform is a durable, sustainable and robust form legible in the vast landscape and references the ancient history of the role of the sun, the recent mining past of Broken Hill, the geology, the source of the Cadmium and Tellurium and local landforms with dramatic effect.

CONSTRUCTIO MATERIALS: Rammed earth walls, sandstone pavers, and a corten steel canopy. The materials have been selected to be constructed from the earth and part of the earth as a strong landscape element. The materials are durable, not effected by weather, require little or no maintenance and will age beautifully over time. The rammed earth would be formed using reclaimed local soil and stone from previous excavations and rise from the red landscape.

The massive and ancient materials are selected to contrast, and not compete with, the new technology and materiality of the photo voltaic modules. In doing so allowing the glistening plant to be the feature. The selection of local materials, and predominantly reclaimed earth, references the long indigenous history and our relationship with the earth whilst rising up to and celebrating the sun and light.

BIOGRAPHY: Winwood Mckenzie Architecture believes in the potential for architecture to create meaningful and delightful spaces that improve lives and the built environment whilst respecting the natural world. Our work within the existing urban fabric and natural landscapes is sensitive; demonstrating our responsibility to the context and environment. We are interested in the physical presence of a space created through its materiality and quality of light. How it feels, is inhabited, is used and enjoyed. Our approach allows us to work on a broad range of building types. We work closely and collaboratively with builders and suppliers we achieve high quality, economical, durable, sustainable and well-performing buildings within budget and time constraints. Founded in 2010 and located in Melbourne, Winwood Mckenzie have been awarded multiple industry awards and published widely.

71

VIEWING PLATFORM AND PAVILION OWEN MURPHY

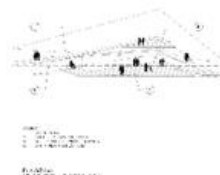
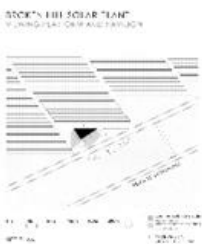
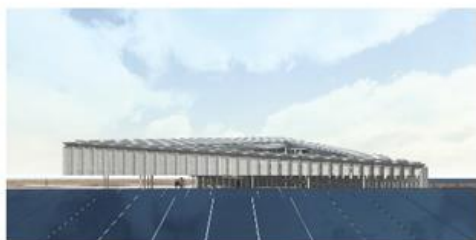

The key elements to the project include a steel frame ramp and platform structure protected by angled galvanised screen and roof elements. The steel frame structure and prefabricated elements allows efficient onsite construction and the opportunity to utilise local skills and trades. The material is robust and has the ability to be recycled at the building's end of life. The use of the galvanised screen becomes a contemporary component that responds to Broken Hill's cultural heritage and its significant zinc deposits. The material is hard wearing in extreme climates and is maintenance free.

DESCRIPTION: This design for the Broken Hill Solar Plant viewing platform aims to emphasise two specific experiences – reprieve and exposure. The project aims to demonstrate an active consideration for passive climatic practices by responding to seasonal solar and diurnal changes and passive ventilation strategies. The proposed pavilion encapsulates the dynamic nature of solar movement through the use of a galvanised screen to moderate exposure. The pavilion is located to create a positive experience with easy access and movement while also promoting an engaging local asset. On arrival visitors are drawn to the reprieve of shade from the elements under a welcoming veranda space below a galvanised screen roof. This flexible space creates the opportunity to exhibit temporary installations and host special events and functions. A ramp provides various framed viewpoints as visitors circulate up to the main viewing platform. The experience within the pavilion is contrasted against the exposure of the viewing lookout. The viewer’s spectrum expands when standing at the platform edge to encapsulate the scale and vastness of the Broken Hill Solar Plant.

BIOGRAPHY Owen Murphy is a recent architectural graduate now practicing in Brisbane.

72

SUN MINE
MAXWELL WEPPNER

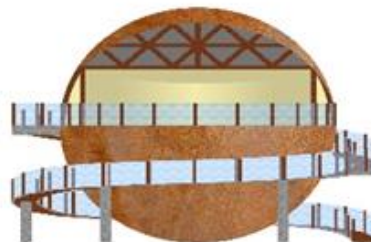

CONSTRUCTION MATERIALS

Wood would need to be used as the basic support for this platform not only due to its properties but also because it is made by the sun so I thought it would be appropriate and topical. The other material would be rendered concrete. This would provide the shape of the sphere itself and would therefore have to be ‘rusty’ in appearance to match the design. Concrete may also be used to provide the heavier support possibly at the base of the structure. In order to create the sphere a steel mesh should cover the structure and the concrete should be poured over/into it to hold it in the shape of a sphere. Glass would also have to be used for the various barriers across the structure

DESCRIPTION

In the spirit of Broken Hill and its history I decided to theme my design around mining as it is a mining town. Solar Power is the process by which one basically extracts energy from the sun, mines the sun. So, I wanted to create my platform around the idea of mining the sun so I could represent the history of the town in this new industry through this design. This is why the main structure is in the shape of a sphere, it is supposed to represent the sun, and the pickaxe at its base represents the mining aspect.

In order to blend with the landscape, I decided the main structure should be rusted in appearance as I thought that would be suitable. I have used a ramp to allow people including disabled people to get up to the platform. In addition to the actual structure, I would like to put cameras at different vantage points around the plant. Through some radio frequency these could be fed back to screens within the structure so that people can view other parts of the solar plant as well as the view provided by the viewing platform. This technology could be powered by the plant itself, again reemphasizing the technology.

BIOGRAPHY

I have just begun my third year studying Electrical and Electronic Engineering at Adelaide University. I am thoroughly enjoying my degree and the subjects I am participating in. Over the past few years I have been developing a keen interest in Sustainable or Renewable Energy and Power systems and I hope to move into the power industry when I graduate. This Solar Plant is a perfect example of something I would like to be involved with and is the main reason why I submitted this design to this competition.

73

ORBITING HORIZON GEORGIA NOWAK AND JAMES GEURTS



CONSTRUCTION MATERIALS: The external walls of the circulation ring are clad in a 10mm mild steel flat plate that has been rolled for curvature. The walls (possibly 200mm thick to allow for structural support) are anchored to appropriate founding depth. The coating of the steel cladding will be rigorously resolved to ensure it doesn't act as a heat sink in the high temperatures. The light source is intended to be hidden within a structural steel member that cantilevers from the walls of the circulation ring. Pending engineer approval. The intended budget of \$350,000 has been considered to include earth works, structural steel, cladding, ramps and access stairs as well as the light source itself. All rendered objects can be managed to ensure a budget sensitive design. Scale of the sculpture can be altered if costing isn't initially met without compromising the design or experiential intent

DESCRIPTION: *Orbiting Horizon* is a light sculpture functioning as an integrated viewing platform of the solar plant. The concept accentuates the ancient and contemporary relationship humans have with the consistent power of the sun and the transformative qualities of renewable solar energy. Approaching the light sculpture, you see the interplay of two circular shapes orbiting around each other on slightly different trajectories. The outside orbiting line is long narrow white light (powered from the plant), extending out from the landscape and obscuring the horizon on a 23.5-degree angle, the angle of earth's rotation around the sun. The second internal orbital line is a circular pathway that first moves through the narrow darkness of the earth via an underground tunnel. The ascending arcs slowly open out revealing the intensifying arid light, then as the visitor approaches the pinnacle viewing point, expands outwardly into the vastness of the solar plant in Broken Hill's landscape. The physical movement around the viewing platform underlines the human movement around the sun. The visitor encounters the line of white light at intervals throughout the pathway, shifting the spatial experience of the body. The shadows cast by the forms would act as a sundial, constantly changing with time of day and the season, shifting the poetic experience of the light sculpture every time you visit. The consistent line of light in the upper orbital ring and the contrasting circular shape with the geometric forms of the solar plant, allow the light sculpture to act as a beacon from the freeway day or night.

BIOGRAPHY:

James Geurts is an artist based in Melbourne and The Hague completing his Masters of Fine Art at RMIT, and The Vrije Academie, GEMAK, Netherlands. James Geurts produces site and time-specific projects that give shape to the dynamics of physical and invisible forces and fields. Geurts' interdisciplinary practice focuses on conceptual lines in perception, and lines constructed within natural space, such as the International Date Line, Equatorial Line, Horizon Lines, and Orbital Lines. He produces site and time-specific projects that draw out dynamics of physical forces and geographic fields. Through critical investigation Geurts aims to give form to selected phenomena that are either too vast, transient or largely invisible. Geurts' practice locates 'paradigms of measurement' and 'psychogeographic methods' as they have unfolded over extended periods of field research. Geurts explores these features using processes ranging from public sculpture, drawing, installation, video, recorded action, ephemeral and permanent site-responsive intervention, photography and living monochromes. Geurts established the on-going conceptual project Embassy for Water in 2011, part of the winning bid for the 2018 European Capital for Culture in Leeuwarden, Netherlands. Geurts has exhibited his projects in galleries and landscape sites worldwide, including White Cube, London; Centre for Contemporary Art, Tel Aviv Israel; Adelaide Biennale of Australian Art; La Chambre Blanche, Quebec; and ACCA, Melbourne.

Georgia Nowak is a registered architect who has studied and worked in both Australia and Sweden for the past 10 years. She has also studied sculpture at the VCA and most recently photography in Paris. Her experience of articulating theory and concept into built form has allowed her to pursue a more ethereal creative practice relating to space, light and most predominantly place. Nowak has contributed to architecture publications such as Assemble Papers, presented at forums at both the NGV and MPavilion and tutored at Monash University. Nowak has received numerous awards for her built interior and architectural projects. **Geurts and Nowak** have a combined interest in the space that sits between art and architecture, continually pushing the tension on where these begin and end. Their collaboration uses combined experiences and skill sets to ensure a robust outcome.

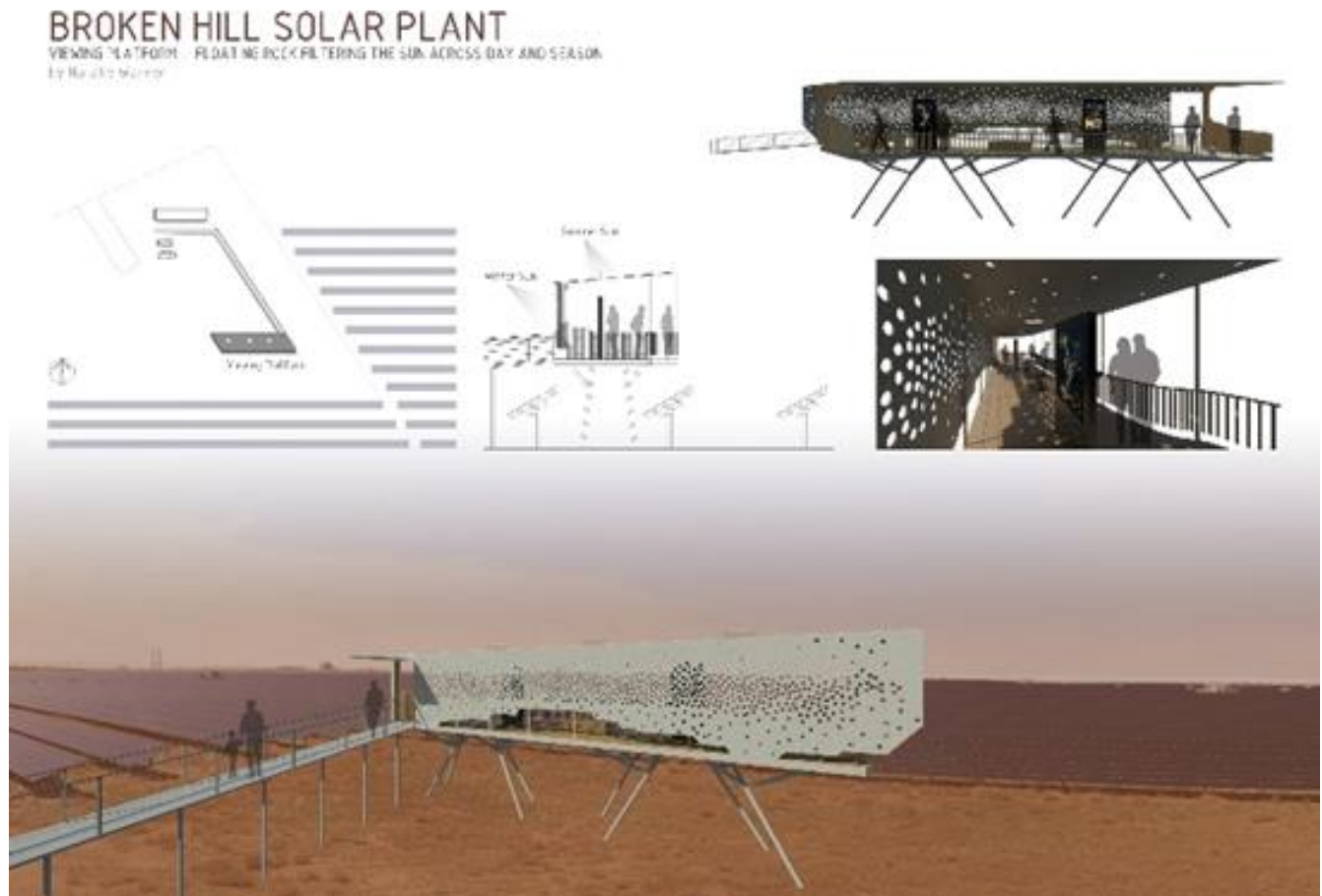

CONSTRUCTION MATERIALS: STRUCTURE (Platform and Ramp) – Steel columns, beams and metal grating ramp – Reason: prefabrication, transportation, construction. PLATFORM SKIN (North Facade and Roof) – Perforated metal, unpainted brushed appearance, semi-reflective (note: cut-outs could be designed with a local artist) – Reason: sun shelter, reflectivity, cut-outs positioned to filter natural light in winter and summer and across the day. INTERIOR FINISHES (Bench Seats, Railings, Floor) – Timber, hard-wearing, sustainable source – Reason: contrast to metal skin, frames view, people-friendly, shaded and natural; DISPLAYS (vertical stands and railing strip) – Black displays and board with information.

DESCRIPTION: Emerging from the weathered, expansive landscape of Broken Hill, the idea is to create a floating rock-like form that showcases the movement of the sun across the day and seasons. The form follows and sits within the angular site in-line with the solar arrays. A long ramp tracks past the solar arrays, leading to a doorway. Once through the doorway an expansive view opens up of the solar plant, framed by a curved railing and slatted timber interior with display signs and bench seats. The long, rectangular platform is shaded by a perforated metal skin on the northern façade and roof. Perforations are positioned to channel winter sun through the northern façade into the interior and filter limited summer sun through the roof. The design is dedicated to the movement of the sun and its ability to power life.

BIOGRAPHY: Brisbane-based independent designer interested in projects exploring landscape, geology, memory, ventilation and natural light. Background in business management in the arts and creative industries but has most recently worked as a Business Analyst for a solar thermal R&D company.

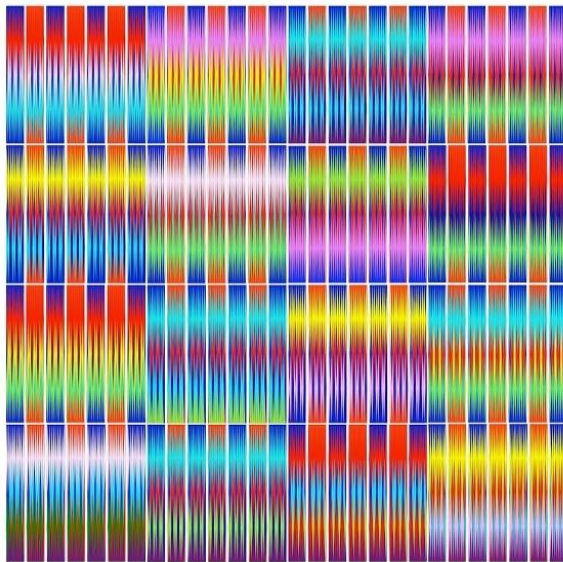

Artist: Philipp Kirsch

Proposal: A Visual Skin for the AGL Viewing Platform

As a visual artist, I do not have the technical training or architectural/building code knowledge and experience to undertake the structural design of the AGL platform.

I am proposing the use of highly painted wooden shipping pallets as the visual skin for the structure, and am submitting a matrix of different designs for pallets. I believe this will be very eye-catching, like a shimmering desert flower colour field from a distance. The dissonance inherent to kinetic art serves to immediately capture any visitor's attention.

This visual design communicates several layers of meaning:

- The colours of the desert across different seasons
- The transformational excitement of sustainable solar energy
- The industrial heritage of Broken Hill - by using shipping pallets.

This visual skin can be adapted to many different structural designs. I enclose a photo of a recently completed sculpture, 'After the box', that documents both the real beauty and the striking materiality of this design.



CONSTRUCTION MATERIALS

I envisage a platform that is hemispherical in shape, with a circular ramp at the starting at the back at the specified grade to enable access for all people. I am guessing the structure would be constructed from a combination of steel (again echoing the importance of BHP and Broken Hill) and concrete. I would suggest sails over the viewing area of the platform to provide shade while maintaining a lightness and excitement for the entire facility. The sails would be printed with the same visual fields of colour that I am proposing for the structural skin. The vertical skin of the platform would consist of painted wooden

shipping pallets attached to the steel frame. I have explained the rationale for using pallets above.

DESCRIPTION: Energy fuels all life on our planet, plants, animals, people, industry and transportation. Renewable energy production is not only critical for global health and sustainability, but also exciting. The sun's energy is the foundation for the entire food chain, captured by plants that feed everything else. The AGL solar farm copies nature, capturing the sun's energy to power human endeavours. Renewably. Sustainably. Integrated in the ecosystem. My art proposal, 'Desert Energy', visually represents the excitement of this solar farm as integrated into the natural and human ecosystem. Grounded in the field of kinetic art, the design consists of a basic geometric pattern that repeats across blocks using different colour combinations. Each block starts with a background motif of alternating deep blue and red-brown vertical bars that echo both the lines of the solar farm against the desert ground, and the shipping pallet ubiquitous to global industry in homage to the key role that Broken Hill has played in Australia's economy. Bands of thin vertical diamonds and triangles are layered over the background motif with the possibility for infinite colour combinations. These lines of complementary or contrasting colours represent the colours of the desert across the seasons, the incredible excitement of electrical power, and the rainbow diversity of opportunity that energy facilitates in our society. When these blocks are integrated together, the viewing platform will 'shimmer' and capture the viewers eye drawing attention to the colours and the electrical wave patterns. A mirage of gorgeous exciting colours will float in the mirage of the desert sun.

BIOGRAPHY: I am interested in what should or should not be considered beautiful, and in how the realization of beauty can be a stepping stone to new beginnings. I am very excited about this project because I believe the increasing use of sustainable energy is a critical new beginning for the transformation of Australian industry and key to the country's future. My art is born in a life of new beginnings, many journeys, different continents, scientist and entomologist, horticulture and mining, entrepreneur and professor, teacher and parent. In this throw away world, I want to pause and breathe and see the colour, and the beauty in the everyday. My themes centre on the wonder of nature, science and mathematics, and also exploring human values of sustainability and justice. My work includes acrylic paintings; organic sculpture with natural materials; formal sculptures that explore op-art; kinetic art and colour theory' works with painted geometric grids and nails that explore the materiality of metals; and large public sculptures constructed from wooden shipping pallets. My formal art practice started in September 2015. In January 2017, I started entering my works in different art prizes in Australia. Two of my works, including 'After the box' – a shipping pallet cube painted with geometric colour fields, were selected as finalists for the Inaugural \$10,000 Kingaroy Sculpture prize.

- Website: www.artistdreaming.com
- Professional cv: <https://au.linkedin.com/in/philippkirsch>
- Publications: <https://uq.academia.edu/PhilippKirsch>

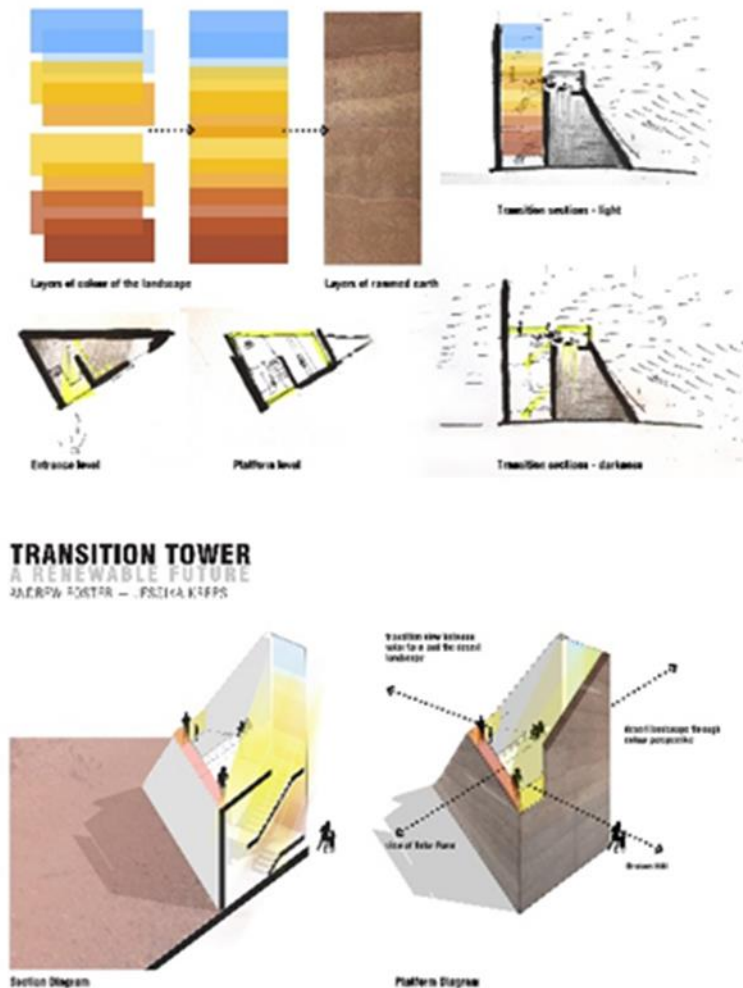

CONSTRUCTION MATERIALS

Our Proposal is to be constructed principally of rammed earth (or 'pisé'), an ancient, traditional earth building technique involving compacting earth, used throughout the world. Given Australia's dry climate and abundant earth, we consider it an ideal material due to its sustainable qualities, the location and purpose. The material is found on-site, and rather than digging into the earth in search of precious natural resources, we would be re-using this earth in order to construct the platform. In order to strengthen the structural qualities of the structure, a concrete mixture of 10% would be added to the earth in order to add reinforcement, being sufficient. Rammed earth has incredible thermal mass qualities, reciprocating to the credentials of solar energy and the solar farm. The pattern of the platform would be unique given the particular visual characteristics and qualities of rammed earth as a material – thus allowing special patterns of layered earth to be integrated into the design, as well as detailed relief patterns. An additional material used in a small but very important capacity to the project, is coloured glass. The overlapping coloured glass panes, relate to similarly structured layers of rammed earth. The layers of colours of the mentioned materials allow the platform to become a symbol of its place, a timeless structure, quietly sitting above the landscape.

DESCRIPTION: Our proposal for a viewing platform at the AGL Broken Hill Solar Farm takes on the idea of being in transition. Through combining different factors of the design, we aim to draw attention of the visitor to the presence and power of the sun. The notion of a transition in the landscape, from a brutal plane of mines, to a sea of solar panels. The transition of the unique colours of the outback. The transition in elevation from the ground plane, to the platform level of 5.5 m. The Visitor Experience The platform sits stoically still, as a sculpture in the landscape. One begins the experience of coming into the space by entering the dark, cool volume with slivers of natural light filtering through the perforated slab above. The coloured glass wall draws the visitor's attention to the colours of the landscape. The staircase attempts to exaggerate this experience and to think about the light and surrounds in a more profound way. The colours representing the earth, sun and sky, have been taken from the surrounding landscape, overlaid in a contemporary stained glass window. Atop the platform, the visitor seeks shade provided by the higher walls on the northern side. The platform provides both views to the city of Broken Hill and towards the AGL Solar Farm. An additional view is offered from tiered seating, of what we call the "Transitional View" – a view between the desert and the solar farm – two powerful entities: nature and technology.

BIOGRAPHY: Andrew Foster Graduate Architect – born Sydney, NSW. After recently completing the Master of Architecture at the University of Newcastle, Andrew is now preparing to open his own design studio for architecture in Newcastle. Andrew has experience working in architectural practices in Sydney (JPW) as well as overseas in Berlin (F-A-R Architekten), Spain (RCR Arquitectes) and London (Foster+Partners). Aside from architecture, Andrew shares a passion for the environment, nature + landscapes and currently tutors Architectural Design at the University of Newcastle.

Jessika Kreps Graduate Architect – born Gdansk, Poland. Jessika is a Graduate Architect from the northern Polish city of Gdansk. Currently operating in Newcastle NSW. Passionate about different forms of discovering the world through observing contextual behaviour of architecture and landscape, its patterns and textures. Enjoying my time sewing and drawing. Interested in public installations, and green public spaces, truly connected with nature and green ways of thinking +living. Our emerging collaborative practice got shortlisted in the national Tapestry Design Prize for Architects and additionally got awarded the People’s Choice Award in August, 2016 for our work Hole in The Wall. Apart from our mutual practise achievements, Jessika has launched several space-related publications:
- Public Space Design Manual – green public space Section: https://issuu.com/hanop/docs/msrl_public_manual and
- Gdansk Architectural Guide (DOM publisher)

77

NEW HORIZONS TRY AUSTRALIA



CONSTRUCTION MATERIALS:

Sympathetic to the environmental theme of the renewable energy site, the viewing platform design rebirths shipping containers into a high-profile energy efficient, affordable and durable local iconic structure. In addition to minimising the environmental impact, reducing build time and costs, extreme durability against the elements and structural strength, the design reduces internal temperature variations whilst delivering improved energy efficiencies.

The structure’s external skin is coated with high tech, heat shielding paint. The internal frame and walls are generously encased in spray foam insulation covered by a variety of energy efficient architectural mediums, with a high preference for the incorporation of locally sourced materials.

DESCRIPTION

Energy efficient glazing provides an abundance of natural light, highlights the glass filled architectural features, whilst contributing to visitor comfort and lower energy costs. Extensive use of renewable, highly durable wood decking and panelling with add to the internal ambience whilst reducing heat transference. Clever airflow designs will enhance visitor's comfort levels with adding to mechanical power drain.

Community participation, which enhances the futures of local disadvantaged young people through training and skills development whilst delivering a local iconic feature will deliver a hallmark legacy for Broken Hill. The exterior walls incorporate decorative laser-cut artwork stencils commissioned by local artists and or students, backlit with solar powered led lighting. The open floor plan, high ceilings and flexible space utilization are conducive to a multitude of uses including education, community meeting rooms, administration, pop-up retail / tourism stations,

function rooms, theatrette, indoor and outdoor dining, etc. Inclined ramps at the sides and rear of the structure provide easy access to the upper level viewing platform for people of all ages and physical capabilities. The glazed upper deck viewing platform allows for up to 100 people to have uninterrupted views of the site from internal air-conditioned areas or from the open-air deck. Use of solar powered led lighting and energy efficient services contribute to the low carbon footprint of the site. The project design allows for works to be prefabricated off-site and completed on-site.

BIOGRAPHY

TRY is Australia' oldest non-denominational youth mentoring charity. Our rich history is one of innovation and creativity; providing mentoring and life changing opportunities for disadvantaged sections of the community for over 134 years. As a pioneer in the social entrepreneur space, TRY Australia envisions innovative ways to engage with local communities to build work related skills, qualifications of local young people and provide opportunities to experience the dignity of work. Our social enterprises provide training, skills and personal development and employment opportunities for disadvantaged and disengaged members of the community, particularly youth. All profits from works done by our social enterprises are used to continue the services and programs available within the community. Two of our social enterprises, TRY Build and TRY Learning, would collaborate with the local community to finalise the design, project manage the construction, deliver training and co-ordinate stakeholder management associated with the project.

78

MINE HEAD VIEW BENJAMIN HEFFERNAN

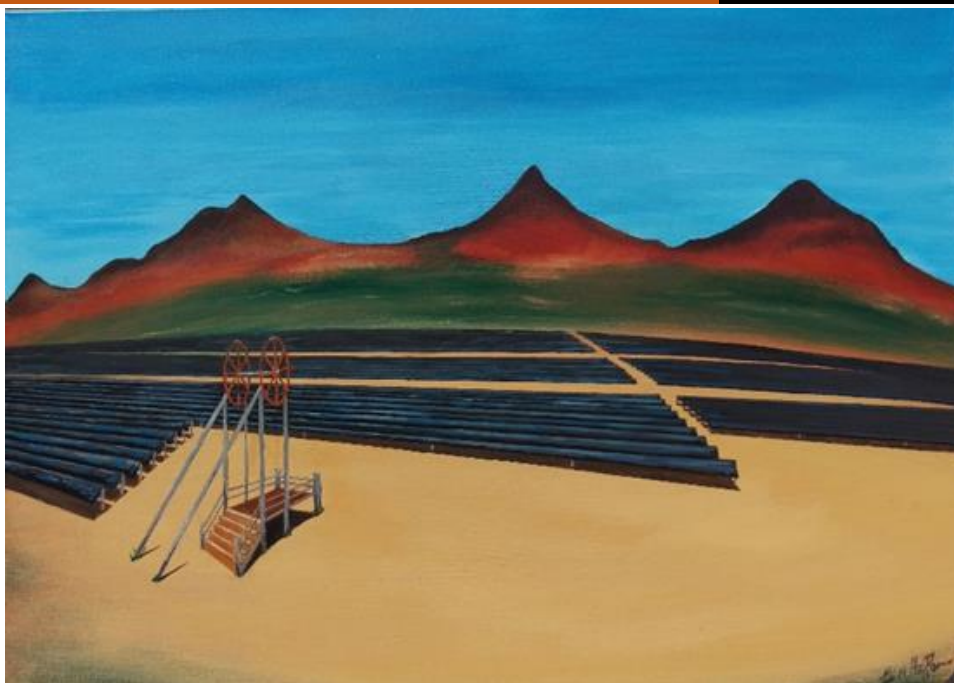

CONSTRUCTION MATERIALS
Metal structure.

DESCRIPTION Mine head tower overlooking the solar farm. In keeping with the mining history of Broken Hill I thought it would be fitting to pay tribute to the thriving mining industry that has helped to make Broken Hill the awesome tourist hub it has become. As visitors come and have a look at the modern technology of our solar farm they can also be reminded of our history.

BIOGRAPHY

I'm a truckie that dabbles in art whenever I get the chance.



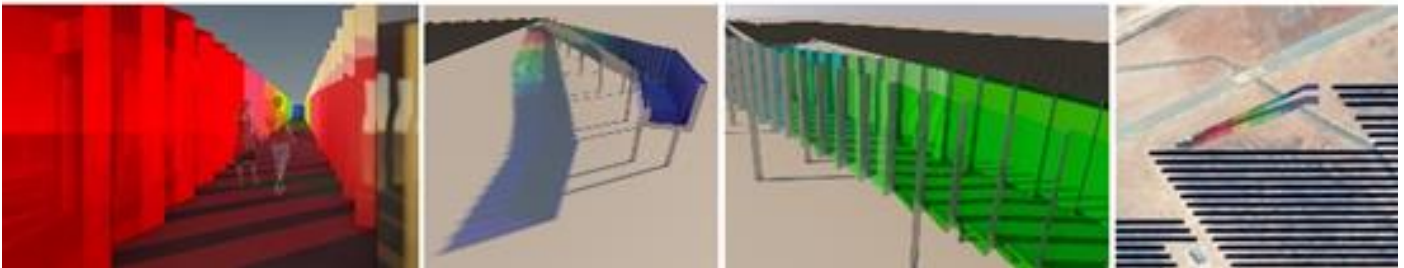
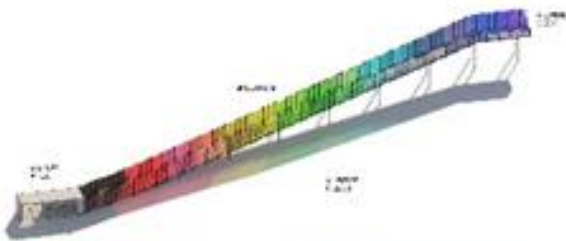
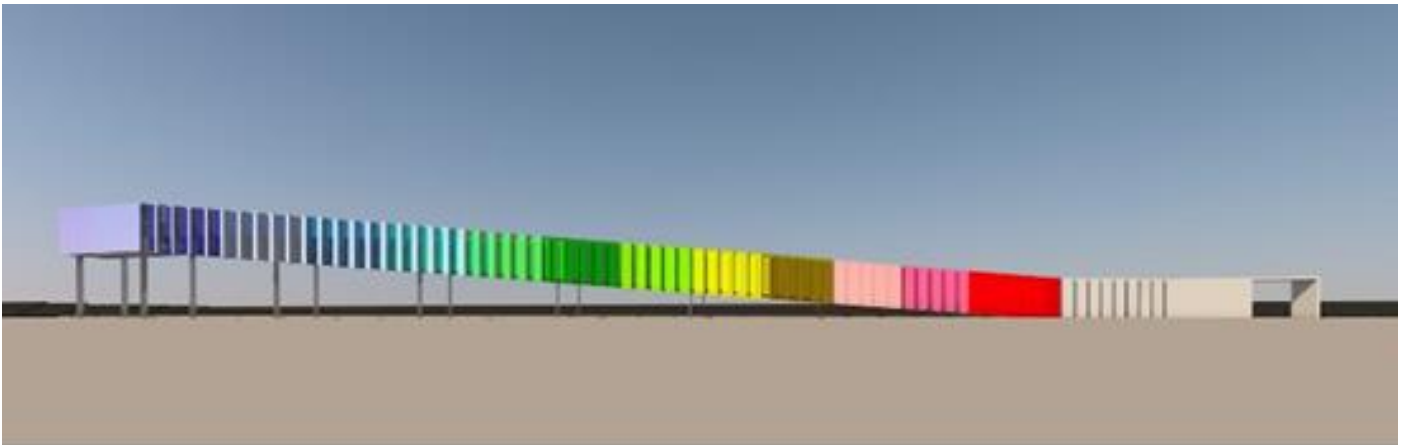

CONSTRUCTION MATERIALS

Steel frame and platform deck, steel vertical fins (possible corten steel), glass with 3M coloured film, concrete panels on concrete slab at base.

DESCRIPTION

SPECTRUM is a viewing platform designed to be accessible to all. The concept is for users to pass through a kaleidoscopic 'rainbow' of colour, light, shadow, and reflection before viewing the Solar array below. It is a highly sculptural element that plays with the beauty of natural sunlight, in contrast to the solar array below which is using the sun's light to create energy. It is also designed to be seen from space.

BIOGRAPHY

I am a sole practicing architect based in Melbourne.

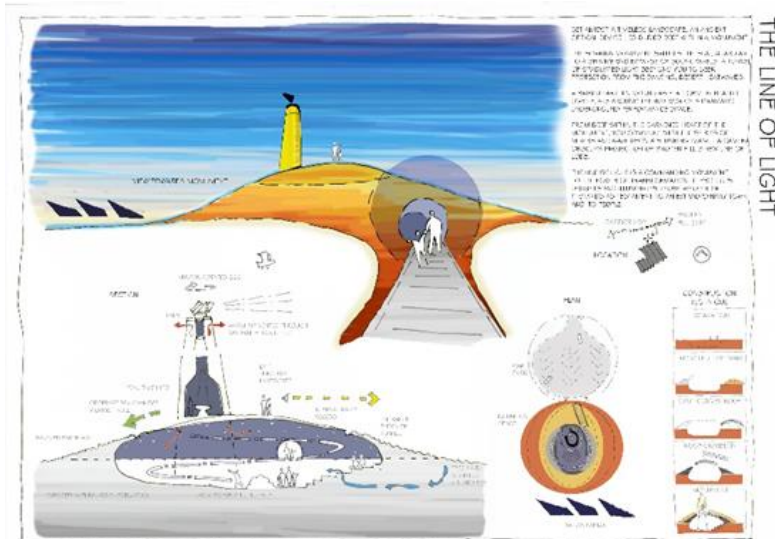

CONSTRUCTION MATERIALS

Construction techniques for the Line of Light have been selected on the basis of cost effectiveness and environmental sustainability. The techniques are both ancient and modern with existing precedent. First, the exhibition space would be formed by excavating into the ground an oval measuring 20 x 30m. Some exposed rock would be retained in situ and become part of the interior experience. Second, the ground would be stabilised and an oval retaining wall formed using locally sourced recycled tyres layered in a herring bone pattern and rammed with earth. Third, the precast concrete convex roof would be cast on the

ground, on site. The convex moulds for the concrete casting would be formed using the excavated soil and steel edging reinforced with steel wire.

The roof panels would then be craned into place. Fourth, the cylindrical tower would be constructed from steel beams in a method similar to that of a poppet head. The tower and chamber would be over-clad in steel plate. Fifth, the recycled tyre exhibition space would be covered in soil externally and be treated internally with a rough coating. Finally, the exhibition space would be naturally ventilated using the tower to create ventilation stack. Fresh air would be drawn in via earth air heat exchangers using the relatively stable ground temperature to either heat or cool the entering air. Daylight would be filtered using light tubes. Electrical power would be sourced from AGL Broken Hill solar plant.

DESCRIPTION

Set amidst a timeless landscape, an ancient optical device lies buried deep within a monument. The soaring monument salutes the sun, guardian to a shimmering expanse of solar panels. A tunnel of graduated light beckons you to seek protection from the dancing, desert heatwaves. A raised earthen mound as platform. Beneath it, light plays around the interior of a dramatic underground performance space. From deep within the darkened heart of the monument, you commune with the spirits of miners and gaze upon a stunning image - a camera obscura projection of broken hill's new line of lode

The line of light is a commanding monument to the power of transformation. It protects, delights and illuminates those who enter. it stands as testament to an extraordinary town and its people.

BIOGRAPHY

Janine and Richard bring a mix of international experience and strong local connections. Janine, a professional writer, was born in Broken Hill to a long lineage of Broken Hill miners. Richard, an architect, originally hails from Guildford, Surrey, in the United Kingdom. Having lived in the UK for many years, they recently relocated to Australia with their two children. Their work has previously been shortlisted for a UK-based design award for renowned technology company Dyson.

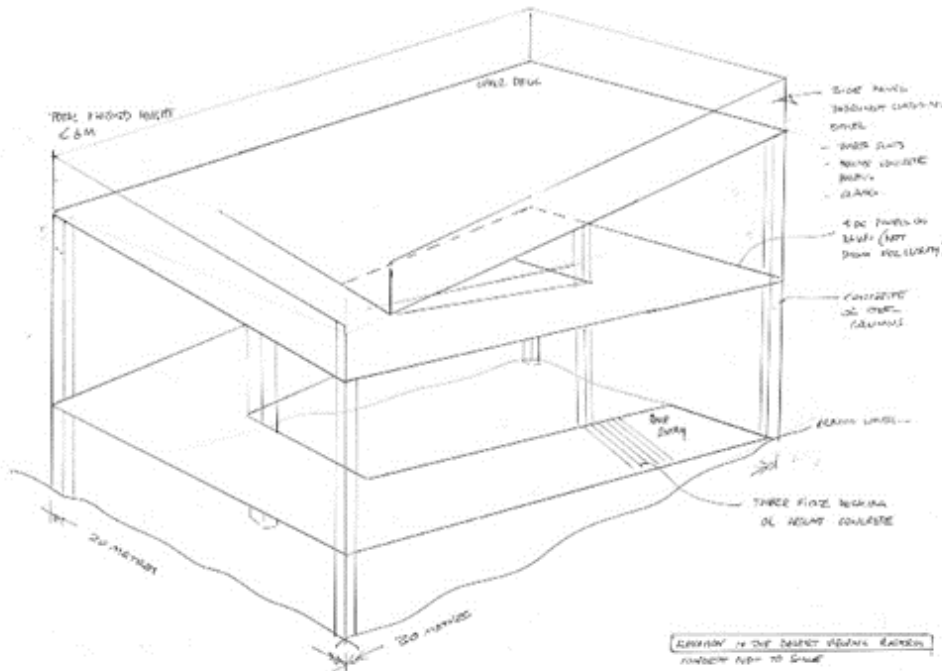

CONSTRUCTION MATERIALS

The structure is designed to be constructed in a modular fashion that can be quickly erected on site to minimise time and cost. Precast concrete columns support galvanised steel joists which in turn provide support for hardwood decking type flooring. This means that all components can be made economically in a major capital city and transported to site for rapid construction by cranes without the costs associated with stick built construction.

DESCRIPTION

Elevation in the Desert is a proposal to enable 50 or more visitors to the AGL Broken Hill Solar Farm to gain an elevated viewing vantage point up to 6m above ground level to enjoy both the spectacle of the Solar Panel Array and the majestic surrounds of the desert. It comprises a rectangular helical ramp that spirals to the uppermost deck enabling visitors to enjoy 360 degree views as they ascend to the top deck.

BIOGRAPHY

I am a qualified engineer and project manager currently employed by AGL at Torrens Island Power Station.

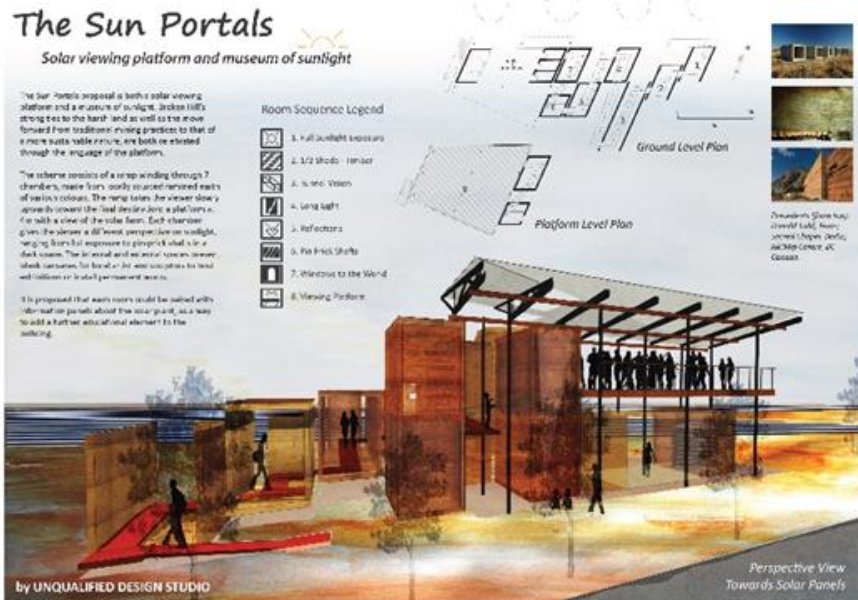
**CONSTRUCTION MATERIALS:**

Rammed earth, recycled timber and corrugated iron. Rammed earth is an under-utilised resource that can be locally sourced, carrying less embodied energy than concrete. It is very strong in compression, has good thermal mass properties and allows the building to sit naturally in its surroundings. Recycled timber is both ecologically sustainable and adds a degree of warmth to the building. Corrugated iron would be incorporated for the rolling due to its light weight characteristics and its place in the Australian vernacular architecture, particularly in regional areas.

DESCRIPTION

The Sun Portals proposal is both a solar viewing platform and a museum of sunlight. Broken Hill's strong ties to its harsh environment as well as the move forward from traditional mining practices to that of a more sustainable nature, are both celebrated through the language of the platform. The scheme consists of a ramp winding through 7 chambers, made from locally sourced rammed earth of various colours.

The ramp takes the viewer slowly upwards towards the final destination: a platform at 4m with a view of the solar farm. Each chamber gives the viewer a different perspective on sunlight, ranging from full exposure to pin-prick shafts in a dark space. The journey up the ramp provides glimpses of the solar farm, however the full view is withheld until the platform. The internal and external spaces present blank canvases for local artist and sculptors to host exhibitions or install permanent works. It is proposed that each room could be paired with information panels about the solar plant, as a way to add a further educational element to the building.

BIOGRAPHY

Unqualified Design Studio is a collaborative practice of young architects, artists and fabricators. We create interactive experiences to inspire and engage diverse audiences. Our aim is to transform participants into active contributors to the creative process, by generating roles and provoking actions, blurring the distinction between performer and spectator. The group has come together through a variety of creative initiatives including HSBNE, Modifyre, and The Wonky Queenslander.

Tripod (without canopy)



Showing the canopy at various angles

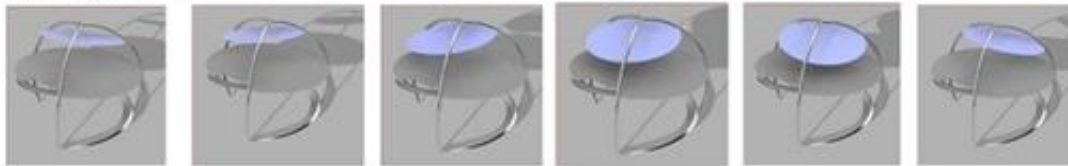

CONSTRUCTION MATERIALS

The legs may be stainless steel or a silver colour in a nod to the name given to Broken Hill at times of 'Silver City'. The roof may either be sun shade material or possibly heavier if solar panels are to be placed on it. A glass safety barrier around the perimeter of the deck and along the spiral ramp is an option that may also protect from driving wind. The deck may be made of mesh to provide air flow and not trap heat.

DESCRIPTION

The proposed platform is circular and supported by a tripod consisting of curved arches. The platform has a spiral arch leading up to it that not only provides form but provides disabled access.

The dimensions may vary however a tripod 10 metres high can support a platform some 12m in diameter at 5.5 m elevation. Such dimensions provide enough space for groups of people to both view the solar farm and still provide space for educational displays behind them.

BIOGRAPHY

Inventor of the orbital shelter. Long-time public servant working to conserve biodiversity.

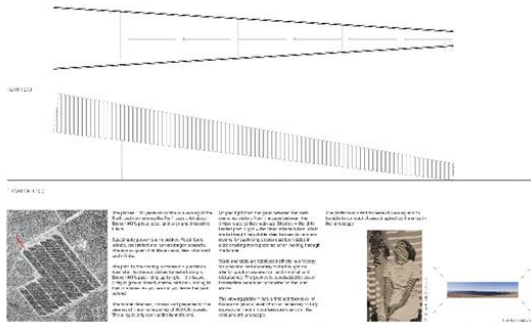

earth mining to unlimited sun mining

CONSTRUCTION MATERIALS:

Sustainability is essential for our future. Materials proposed have been selected for their sustainability - timber and steel. Local materials are proposed where possible to minimise carbon miles and keep employment local. These materials require low to no maintenance. Timber, being a renewable resource, is proposed for the slatted cladding walls and slatted roof, and floor surface. No timber would be old growth, imported or from rainforests, and preferably be from plantations. The double layer of slatted battens are nominally 40x40mm hardwood spaced 40mm. Design development may later alter these sizes and spacing to enhance the experience of the journey. The battens are either

side of the steel trusses making it a double layer. A discreet slatted timber on steel door may be necessary at the entrance for out of hours' security. Steel, although energy intensive to make is thereafter recyclable. It is proposed as the spanning trussed structure as it is recyclable. Steel is an efficient light weight means for such long spans. Walls, roof and floor are fabricated off site in a factory for precision and economy to be brought on site for quick crane erection and minimal land disturbance. Australian steel would be the first choice to minimise carbon miles. A glass balustrade concludes the tunnel. The structure is supported in thin steel columns which in turn go into the ground onto concrete footings.

DESCRIPTION: The phrase '130 years of continuous mining of the Earth and now mining the Sun' says a lot about Broken Hill's proud past, and wise and innovative future. Sustainable power is a no brainer. Fossil fuels pollute, are limited and can no longer compete. The sun as giver of all life is clean, free, abundant and infinite. The path to the viewing platform is a slatted timber tunnel alluding to Broken Hill's past rising up to light – the future. Entry is ground based, narrow and dark hinting to that of a mine. As you walk in you leave the past behind. The tunnel cleanses, informs and prepares for the viewing of the amazing array of 600,000 panels. The array is only seen at the tunnel's end. Striped light from the gaps between the slats drenches visitors from the gaps between the timber slats as they walk up. Shadow = the dirty limited past. Light = the clean infinite future.

The journey is punctuated by seven information panels as nominated on the plan above. The viewing platform has a finished floor level of 6m above ground level which is necessary to fully appreciate the shiny contemporary array in the vast ancient landscape. The platform is sized for ease of viewing and to be able to conduct classes inspired by the array in the landscape.

BIOGRAPHY: Sam Marshall is best known for being the architect of the award-winning Museum of Contemporary Art Australia in Sydney. Other notable works include Object Gallery, the Darren Knight Gallery, an extension to Campbelltown Arts Centre, numerous residential projects and retail stores in Paddington and New York.

Sam Marshall has been a practicing architect for 34 years, 26 as director and designer at Architect Marshall Pty Ltd. For his Darlinghurst warehouse conversion, he was awarded the prestigious 2000 RAIWA Wilkinson Award, RAIWA President's Award for Recycled Buildings and an RAIWA Conservation Award. He has also won the Marrickville Medal and the Byera Hadley Travelling Scholarship. He has worked with many artists in collaboration. He has been a Member of the NSW Ministry for the Arts Capital Infrastructure Committee and a Board Member Australian Centre for Photography.

From an early age, Sam was inspired by his mother to be creative and by his practical engineer father to use the earth's resources wisely and economically so they would be there for future generations. Sustainability is integral to his built form

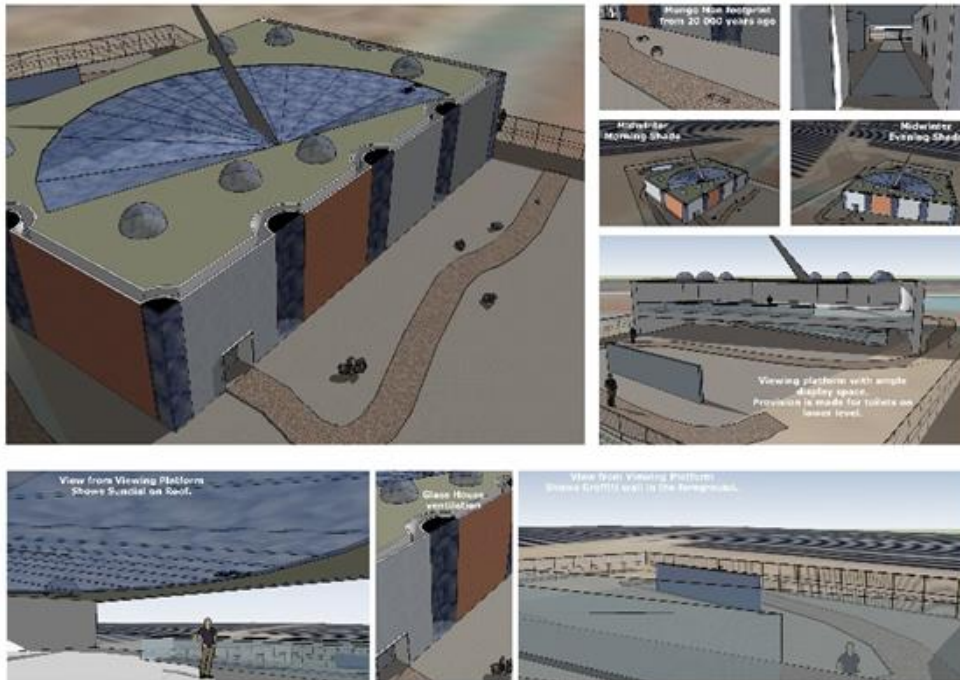
**CONSTRUCTION MATERIALS**

The structure is reinforced concrete slabs. These are hard wearing and require minimal maintenance. The structure has a double wall construction, to provide additional insulation. A suitable surface treatment can be applied to give each face a unique finish. Rust Paint would provide an old mine rusted metal look. Thin sheet metal on the surface is an option.

The Solar Thermal Chimneys are enclosed in glass. The interior is a matt black. This

amplifies the glass house effect within the chimney creating stronger convection and so draw more air out of the structure itself.

The roof is a frosted glass or thick canvas or shade netting. At least 90% UV cut. The hourglass marking can be simple aluminium square tubing mounted on the inside of the roof. The hand rails on the ramp and the security railing across the front of the viewing platform are Anodised aluminium and Glass. The Aluminium is a nod to the Bauxite from Broken Hill and the Aluminium along with Glass will provide a secure and unobstructed view for young and old. These do not corrode and provide maximum longevity to the project. The Graffiti wall is to be reinforced concrete with a layer of glass on the side facing the viewing platform. Concrete responds well to chalk, Markers (Sharpie™) and paint. The glass face is easy to clean with turpentine or acetone should it be defaced with something offensive. The view from the platform can remain benign.

DESCRIPTION

The path leaving the car park has a replica of the footprints left by Mungo Man on this land twenty thousand years ago. This draws us back to a time when the Aboriginal people, unhindered, roamed these lands under the scorching sun. Following the path from the car park, the visitor will pass rock art of the First People of this region. The platform stands as a monolith rising up with hard lines and sharp edges to show how man has forced his will on the land. The colour and texture speak to the Lead, Zinc, Silver, Gold and Bauxite mined from beneath Broken Hill. Deep black gouges surround the structure. Scars from mining, from pick, drill, and blasting. But these scars form chimneys to draw the warm air from the platform. The visitor can then follow the walkway into the monolith and up to the viewing platform. Here we can look out across the Solar Farm where modern man is once again learning to rely on the Sun for sustenance. Gazing up, the roof is a semi-transparent sundial marking the passage of time. Just in front of the viewing platform is a Graffiti wall. Please go and make your mark on this wall. This is a reflection of how we will always have an impact on the land we stand upon. We can choose to make that impact harmful, or harmonious. This reflects the Spirit within those visiting this land.

BIOGRAPHY: I immigrated with my family to Australia from South Africa in 2009. I have worked as an engineer in the rooftop solar industry. We look forward to building a good life in Australia and have become citizens.

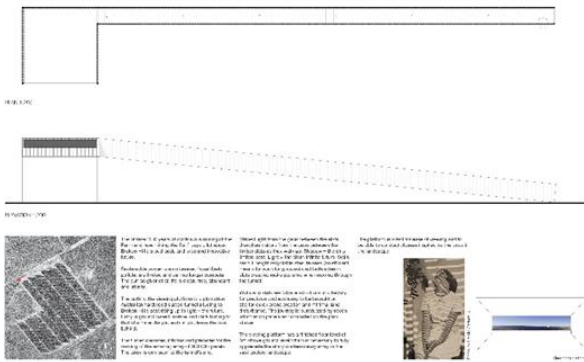

earth mining to unlimited sun mining

CONSTRUCTION MATERIALS

inability - timber and steel. Local materials are proposed where possible to minimise carbon miles and keep employment local.

These materials require low to no maintenance.

Timber, being a renewable resource, is proposed for the slatted cladding walls and slatted roof, and floor surface. No timber would be old growth, imported or from rainforests, and preferably be from plantations.

The double layer of slatted battens are nominally 40x40mm hardwood spaced 40mm. Design development may later alter these sizes and spacing to enhance the experience of the journey. The battens are either side of the steel trusses making it a double layer. A discreet slatted timber on steel door may be necessary at the entrance for out of hours security. Steel, although energy intensive to make is thereafter recyclable. It is proposed as the spanning trussed structure as it is recyclable. Steel is an efficient light weight means for such long spans. Walls, roof and floor are fabricated off site in a factory for precision and economy to be brought on site for quick crane erection and minimal land disturbance. Australian steel would be the first choice to minimise carbon miles. A glass balustrade concludes the tunnel. The structure is supported in thin steel columns which in turn go into the ground onto concrete footings.

DESCRIPTION: The phrase ‘130 years of continuous mining of the Earth and now mining the Sun’ says a lot about Broken Hill’s proud past, and wise and innovative future. Sustainable power is a no brainer. Fossil fuels pollute, are limited and can no longer compete. The sun as giver of all life is clean, free, abundant and infinite. The path to the viewing platform is a slatted timber tunnel alluding to Broken Hill’s past rising up to light – the future. Entry is ground based, narrow and dark hinting to that of a mine. As you walk in you leave the past behind. The tunnel cleanses, informs and prepares for the viewing of the amazing array of 600,000 panels. The array is only seen at the tunnel’s end. Striped light from the gaps between the slats drenches visitors from the gaps between the timber slats as they walk up. Shadow = the dirty limited past. Light = the clean infinite future.

The journey is punctuated by seven information panels as nominated on the plan above. The viewing platform has a finished floor level of 6m above ground level which is necessary to fully appreciate the shiny contemporary array in the vast ancient landscape. The platform is sized for ease of viewing and to be able to conduct classes inspired by the array in the landscape.

BIOGRAPHY: Sam Marshall is best known for being the architect of the award-winning Museum of Contemporary Art Australia in Sydney. Other notable works include Object Gallery, the Darren Knight Gallery, an extension to Campbelltown Arts Centre, numerous residential projects and retail stores in Paddington and New York.

Sam Marshall has been a practicing architect for 34 years, 26 as director and designer at Architect Marshall Pty Ltd. For his Darlinghurst warehouse conversion, he was awarded the prestigious 2000 RIAA Wilkinson Award, RIAA President's Award for Recycled Buildings and an RIAA Conservation Award. He has also won the Marrickville Medal and the Byera Hadley Travelling Scholarship. He has worked with many artists in collaboration. He has been a Member of the NSW Ministry for the Arts Capital Infrastructure Committee and a Board Member Australian Centre for Photography.

From an early age Sam was inspired by his mother to be creative and by his practical engineer father to use the earth's resources wisely and economically so they would be there for future generations. Sustainability is integral to his built form.

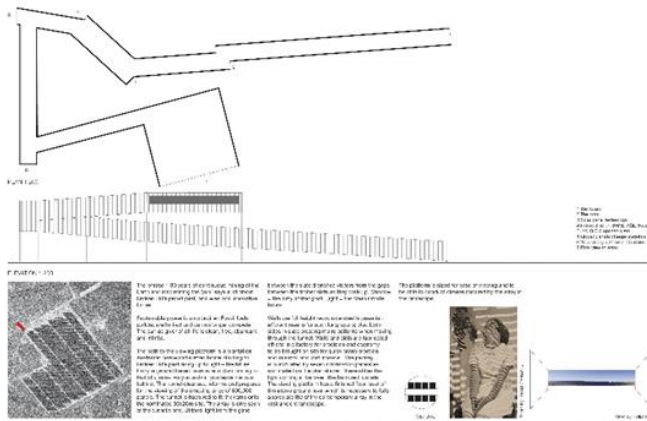

earth mining to unlimited sun mining

CONSTRUCTION MATERIALS:

Sustainability is essential for our future.

Materials proposed have been selected for their sustainability - timber and steel. Local materials are proposed where possible to minimise carbon miles and keep employment local. These materials require low to no maintenance. Timber, being a renewable resource, is proposed for the slatted cladding walls and slatted roof, and floor surface. No timber would be old growth, imported or from rainforests, and preferably be from plantations.

The double layer of slatted battens are nominally 40x40mm hardwood spaced 40mm. Design development may later alter these sizes and spacing to enhance the experience of the journey. The battens are either side of the steel trusses making it a double layer. A discreet slatted timber on steel door may be necessary at the entrance for out of hours security. Steel, although energy intensive to make is thereafter recyclable. It is proposed as the spanning trussed structure as it is recyclable. Steel is an efficient light weight means for such long spans. Walls, roof and floor are fabricated off site in a factory for precision and economy to be brought on site for quick crane erection and minimal land disturbance. Australian steel would be the first choice to minimise carbon miles. A glass balustrade concludes the tunnel. The structure is supported in thin steel columns which in turn go into the ground onto concrete footings.

DESCRIPTION: The phrase '130 years of continuous mining of the Earth and now mining the Sun' says a lot about Broken Hill's proud past, and wise and innovative future. Sustainable power is a no brainer. Fossil fuels pollute, are limited and can no longer compete. The sun as giver of all life is clean, free, abundant and infinite. The path to the viewing platform is a slatted timber tunnel alluding to Broken Hill's past rising up to light – the future. Entry is ground based, narrow and dark hinting to that of a mine. As you walk in you leave the past behind. The tunnel cleanses, informs and prepares for the viewing of the amazing array of 600,000 panels. The array is only seen at the tunnel's end. Striped light from the gaps between the slats drenches visitors from the gaps between the timber slats as they walk up. Shadow = the dirty limited past. Light = the clean infinite future. The journey is punctuated by seven information panels as nominated on the plan above. The viewing platform has a finished floor level of 6m above ground level which is necessary to fully appreciate the shiny contemporary array in the vast ancient landscape. The platform is sized for ease of viewing and to be able to conduct classes inspired by the array in the landscape.

BIOGRAPHY: Sam Marshall is best known for being the architect of the award-winning Museum of Contemporary Art Australia in Sydney. Other notable works include Object Gallery, the Darren Knight Gallery, an extension to Campbelltown Arts Centre, numerous residential projects and retail stores in Paddington and New York.

Sam Marshall has been a practicing architect for 34 years, 26 as director and designer at Architect Marshall Pty Ltd. For his Darlinghurst warehouse conversion, he was awarded the prestigious 2000 RIAA Wilkinson Award, RIAA President's Award for Recycled Buildings and an RIAA Conservation Award. He has also won the Marrickville Medal and the Byera Hadley Travelling Scholarship. He has worked with many artists in collaboration. He has been a Member of the NSW Ministry for the Arts Capital Infrastructure Committee and a Board Member Australian Centre for Photography. From an early age Sam was inspired by his mother to be creative and by his practical engineer father to use the earth's resources wisely and economically so they would be there for future generations. Sustainability is integral to his built form.



CONSTRUCTION MATERIALS

Drawing from the arid setting of Broken Hill and its rich history of mining, the concept is inspired by the inherent beauty of formations found in nature. Its construction is based on the simple tools of creation; mirroring, reflection and the asymmetry of a 'broken cube' on a tilted axis. The cubic structure would be built using reinforced translucent concrete. The translucent concrete utilizes a mix that replaces certain aggregates with recycled plastic particulates, combined with locally sourced black slag rock.

This method provides a sustainable and affordable construction material which can be delivered to the site in prefabricated modular panels or formed in-situ. This building material could be mass-produced and manufactured locally as the concept focuses on local industry contribution and involvement in the fabrication of the pavilion.

As the structure rises and opens towards the solar fields, a cave like volume is revealed that is for the most part, orthogonal and counter balanced with equal length back-spans, making the cantilevered sections inherently buildable. The orientation and embedding of the cubic volume assists both in the pavilion's thermal mass properties and site lines. The internal level change achieves an accessible, elevated platform to create a naturally ventilated breezeway above the arid ground plane.

DESCRIPTION: The platform pavilion is a human-scale realization of the local and geologically dominant mineral; Galena. The architecture and its surroundings are intimately intertwined, informed by the natural and man-made lines of the existing context, to create an enduring and meaningful space. The pavilion provides an exhibition space, an open information auditorium and a raised viewing platform for 50 persons. A venue suited for large gatherings to experience uninterrupted, elevated views of the AGL's Solar Plant field. The reflective field of solar arrays are contrasted by a bold prismatic structure. The pavilion acts as a monolithic, three-dimensional viewport for its visitors; a means for experiencing the endless solar plant, promoting and celebrating Broken Hill's sustainable practices and the technical innovations of AGL. The angled axis of the entry pathway is informed by existing ground conditions and frames the arrival to create a moment of discovery. The pavilion utilises the ramp typology as both a circulation and equitable access strategy and a means to enhance the open plan. The external iconic dark lustre, propitiates the interpretation of Broken Hill's Galena-sphalerite geology. This notion is carried through to the tilted roof surface supporting a solar array. An appropriate and honest demonstration of renewable energy innovation and progressive use of sustainable design.

BIOGRAPHY: We are a collective team of architects and designers working across various design practices in Brisbane, Australia. We are a collaborative team bringing together our combined skills and experience to work on designs that excite and challenge us outside of our 9 - 5 day jobs.

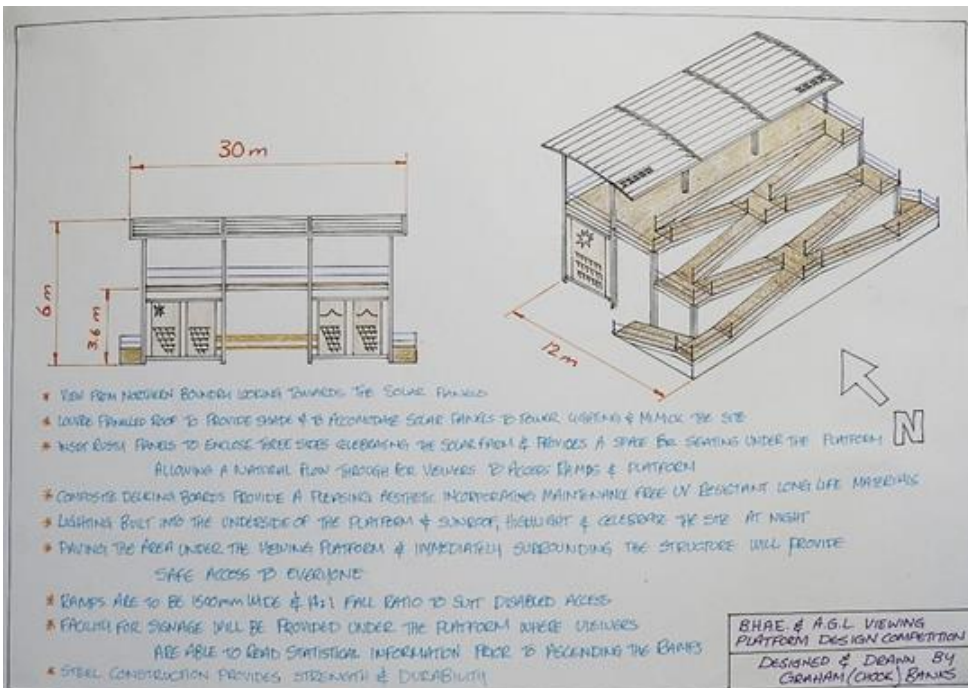

CONSTRUCTION MATERIALS

The construction material would need to be steel as it affords the strength, flexibility and durability of design that requires no further maintenance once the structure is built. To finish off I would pave all ground level areas to provide a flat even surface that is safe and wheelchair friendly, giving the opportunity for everyone to marvel at AGL's achievement in the Broken Hill environs.

DESCRIPTION: The viewing platform I've designed allows everyone to access, the able bodied and disabled alike. It will present the longest side of the structure to align with the rows of solar panels, for maximum benefit to the viewer. It will have an arched shade roof that will have louvered panels to provide maximum shade and imitate the site.

The louvered panels on the roof will house solar panels to charge batteries and power lighting that will see the platform backlit which when viewed at night will become a beacon, celebrating the solar farm.

The raised platform presents an opportunity to utilise the space beneath, providing seating and ample space for signage. This space would be semi open. My proposal is to use Corten Steel (rusty steel) Panels that will have profile cut images to reflect and celebrate the location but also direct viewers through the area housing the signage and or statistical information through to the ramps leading up to the platform.

The platform and ramps themselves will be clad with composite decking boards providing maintenance free, U.V. resistant, attractive, long life, recycled materials. With the ramps being constructed on the southern side of the platform in order to remain sensitive to the shadow line.

BIOGRAPHY:

I'm a loved and loving partner, a tradie turned teacher, a father of four daughters, a grandfather, I'm part time carer for my mum, a part time artist, a part time skydiver, a passionate recycler and someone who cares about our community.

CONSTRUCTION MATERIALS

Rolled steel panels, pre-fabricated in curved sections and assembled on site. Solid steel pole structure supports a rolled-beam structure that in turn carries the spread of the roof. The steel cladding would be of a standard that rusts naturally to a state and then halts, giving a rustic, ochre look and providing a durable, low maintenance surface.

DESCRIPTION

A simple shelter structure large enough to cover a visiting group and host several information plinths and seating benches. The intention is to have this structure sitting atop a mound, with a surface height from ground level of 2 metres. The mound would be circular in shape, with a paved/packed earth gently sloping rampway up to the viewing area. The roof of gently rolled undulations would represent not only the distant hills, but also the corrugated iron so representative of Broken Hill roof architecture.

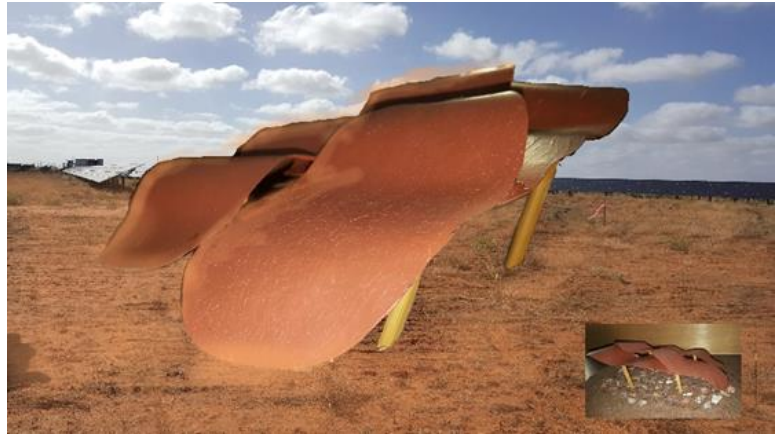

CONSTRUCTION MATERIALS: Banked earth for the ramp up. Perforated metal screens, timber and concrete for the platform structure.

DESCRIPTION: Our viewing platform is an interactive design that allows users to gain a better understanding and appreciation of sun paths and light. At different times of the day and the year the structure seems to change and shift, reflect the movement of the sun. The ramped path to the viewing platform has screens which creates opportunities to display artwork or educational information relating to the solar farm and Broken Hill.

BIOGRAPHY: We are graduates of architecture who are particularly interested in architecture that responds to its environment to enhance user experiences. We are strong believers that the architectural process should create beautifully detailed buildings which are intimately connected to function and have a strong relationship with their surroundings.

SHINGLEBACK LOOKOUT



The shingleback lizard lives in the Flinders Ranges of southern Australia. It is a small lizard that lives in rocky areas, creating a home for itself. It is a very hardy lizard and can survive in the harshest of conditions.

The lookout will be an abstract form of the lizard, using the shingleback's unique pattern of scales to create the look of the lizard's body. The lookout will be made of steel and will be built on a concrete base. The lookout will be built on a concrete base and will be built on a concrete base.

The lookout will be built on a concrete base and will be built on a concrete base. The lookout will be built on a concrete base and will be built on a concrete base.

The lookout will be built on a concrete base and will be built on a concrete base. The lookout will be built on a concrete base and will be built on a concrete base.



The lookout will be built on a concrete base and will be built on a concrete base. The lookout will be built on a concrete base and will be built on a concrete base.

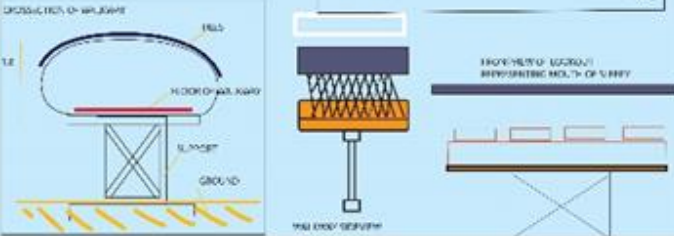

The lookout will be built on a concrete base and will be built on a concrete base. The lookout will be built on a concrete base and will be built on a concrete base.

CONSTRUCTION MATERIALS: Steel construction rust coloured. Solar cell tiles on roof with LEDs used to light outline of cells and structure at night and to light ramp when dark.

DESCRIPTION

Poster presentation of shingle back lookout. An abstract interpretation of the shingleback form used to create the lookout.

BIOGRAPHY

Eve Lyn Kennedy is a local Broken Hill aspiring artist.

93

OUTBACK SUNFLOWER
GERARD MAHONEY
AND KYLE MAHONEY

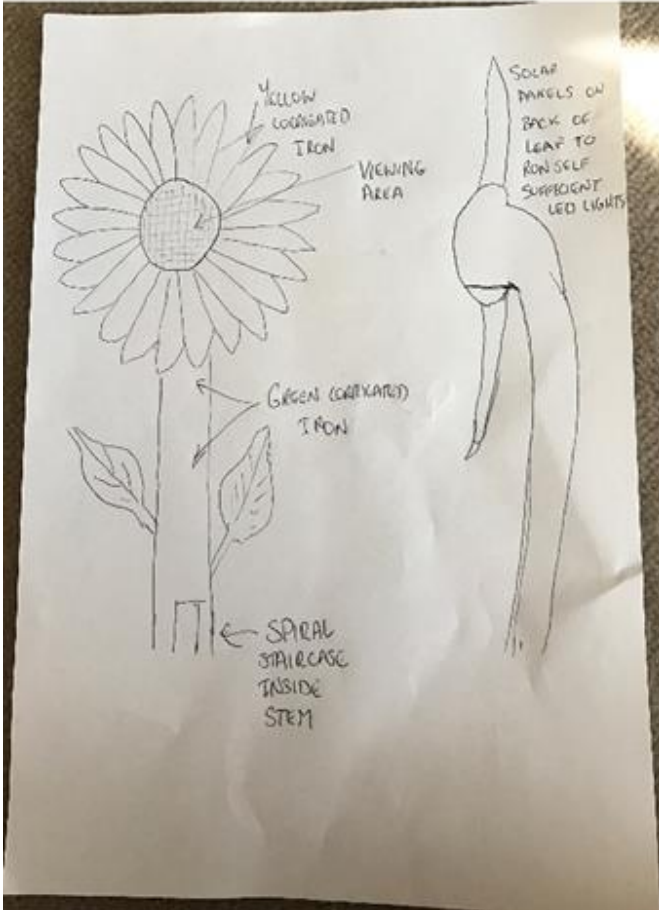

CONSTRUCTION MATERIALS: If our entry was chosen, we would suggest a steel framework with iron cladding. This would be the strongest way of constructing this design, also the most durable

DESCRIPTION

Our design features the Sun Flower as the structure with a hidden viewing platform inside. The sunflower has been chosen to represent the sun, which is the heart and soul of any solar plant. It would be constructed using colour bond corrugated iron as the cladding for the front of the flower. (A building material closely connected to Broken Hill) The rear of the flower would contain solar panels in the centre to power an array of coloured LED lights that would cover the rear of the petals and stem and light up the back in an ever-changing colour/flower type which would be visible from the road/carpark at night. This display would be powered by batteries that were charged by the solar panels during the day

BIOGRAPHY

We are a local family that enjoy the diverse area in which we live and would love to see the solar plant from an elevated position.

94

SUNCHASER
RANDALL JOHNS



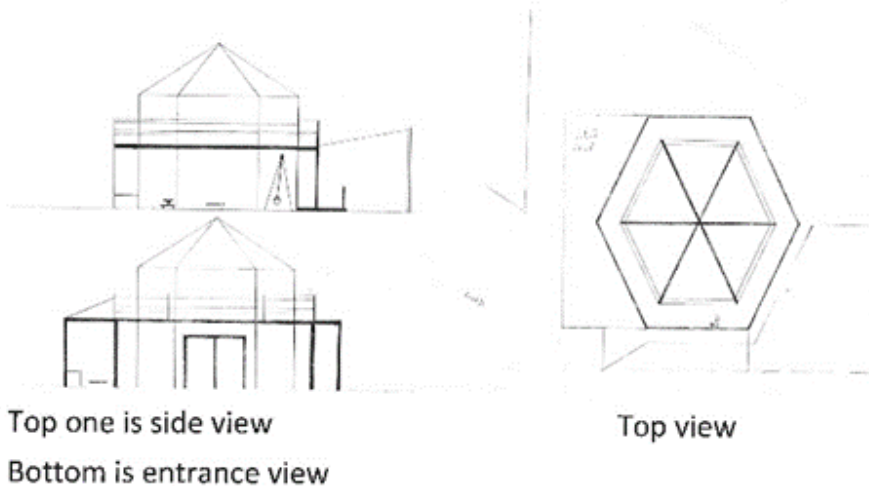

CONSTRUCTION MATERIALS: Foundations will be out of concrete because it is the most suitable for our land conditions and for durability. Main structure (the bones of the building) will be made out of steel because of the durability and sturdiness of the material. The lining of the building for bottom floor will be blue board rendered and insulated.

Top floor will be made out of 32mm glass double glazed with the dark tint (to be decided how dark) the glass panels will be framed by steel with rubber inserts for the viewing floor to create a visual 360 degree viewing platform. The balcony will be made from mod wood decking (mix of timber and recycled plastics) and steel frame for the material is the strongest. The covered entrance will be out of colour bond sheeting with steel frames. All steel frames inside will be covered to soften the look. All covered areas surrounding the main building will be insulated with ceiling sheets (blue board) the BBQ will be a bricked BBQ with recycled timber tables. The play area will be rubber matted and the child safe and Australian standard play equipment.

DESCRIPTION: My proposal is for a two-story building with full 360 balcony for outside viewing, the top floor will be a fully glassed panel for the inside viewing and with the bottom floor being fully enclosed. I want people to be able to see the raw landscape around the farm as well as having full view of the farm to give the viewer a perspective of how the farm is now a part of the land scape.

The viewing platform will be an inviting place to enter for all ages because of its functionality with a covered entrance for buses and cars to be able to drop off out of the elements.

A BBQ area with tables, a play area for children, spiral ramps as egress and ingress covering the disability access (inside on ground floor to first floor) and the full 360-degree view from inside and outside

BIOGRAPHY: I am Cory Paulson. I've lived in Broken Hill for 15 years. I have my wife and three children. I'm an Aboriginal man who loves his culture and loves design. If given the chance as one of the top four I believe I can show you what I'm talking about and impress you with the next level of my idea where you will see the 3d image and the idea will come to life more. I thank you for accepting my entry and good luck choosing a winner.

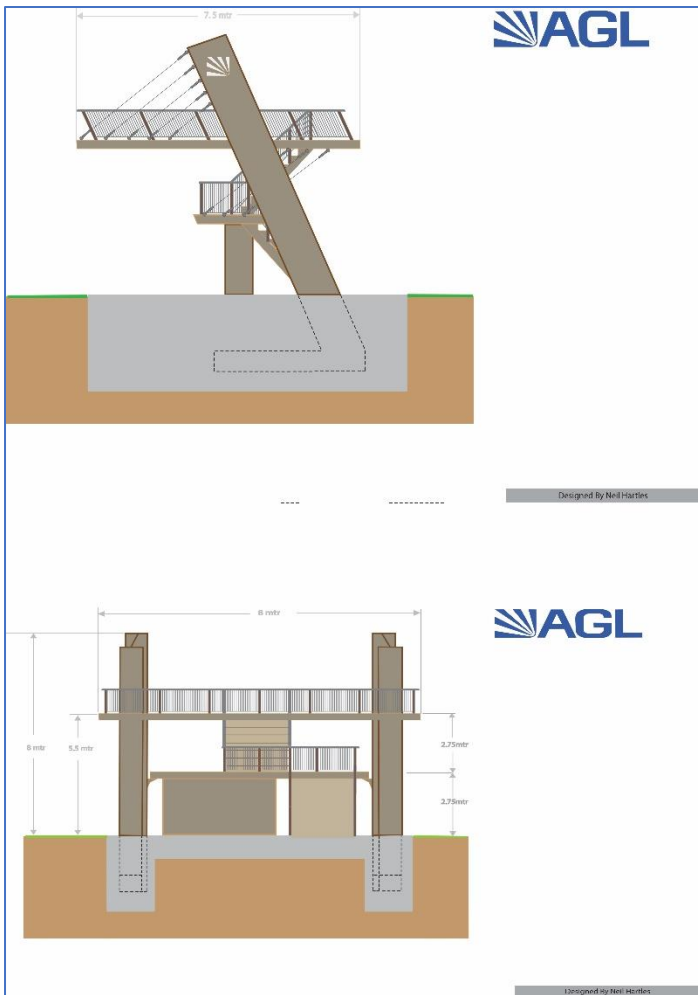

DESCRIPTION: The platform is a modern structure that still reflex the industrial look of some of the structure that are around Broken Hill the angles and cables that support the platform it looks like it defies gravity by hanging out over the vast space of the solar fields and I have named my design (Vision of the Future platform) name can be changed if that doesn't fit with the overall vision of the selection panel. It has an information area at the bottom of the stairs that has auto and visual capabilities.

CONSTRUCTION MATERIALS: The structure is made from steel beam, concrete and steel cables.

The steel work makes up the majority of the structure. There will be 2 large main welded steel beams that come out of the ground and they are the main supports for the platform. These beams can be made to size to meet the required specification to hold up the protruding platform. The welded beam will go into the concrete foundations to stabilise the structure. There will

be steel cables to secure the protruding platform. The handrails and stairs will be made out of steel and steel spindles. The deck will have a steel frame work to houses the concrete deck. The steel work will be coated to withstand the corrosive elements to give it longevity.

BIOGRAPHY:

Neil is currently a full-time artist; painter and sculptor and he has a background in engineering. Neil has had numerous Group and solo exhibition in the Albury and surrounding areas. For over 30 years Neil has worked in the metal trades including engineering, fabrication, metal furniture and traditional blacksmithing. Neil ran his own furniture business (Unique Metal Furnishings - U.M.F.) for a number of years (1997 to 2001) making all types of furniture, chairs, tables, stools, coffee tables, etc. Neil has worked for a number of engineering companies in Albury, Wodonga, Melbourne and the Gold Coast. These include, but are not limited to: Phil's Custom Steel; Larson's Engineering; Albury Steel Fabricators; Wireway Industries Melbourne; and Dream World on the Gold Coast. Neil has recently completed an Advanced Diploma of Visual Arts at TAFE NSW Riverina Institute Albury. As well as his skills in engineering and fabrication Neil has recently completed these courses. Advanced Diploma of Visual Arts (Achieved Distinction Level), Diploma of Visual Arts (Achieved Distinction Level), Certificate IV in Interactive Digital Media, Certificate III in Information, Digital Media and Technology Visual Arts, Crafts and Design, Screen and Media Training package Information and Communication Technology Training package.

**CONSTRUCTION MATERIALS**

Recycled stone and concrete paving base, steel main structure, recycled timber decking and secondary structure, profiled & perforated coated steel claddings

DESCRIPTION

The conceptual basis for this design draws upon two major principles: the “photovoltaic effect”, a direct reference to the installation, and “mining the sun”, describing local activity as it shifts from underground to above ground “mining”.

Conceived as a dual layer walkway, visitors ascend the lower level under sunlight and progress to an “energised” state upon reaching the upper platform. The platform is shaded, open sided and offers views over the installation, with signage able to be displayed on sections of solid walling. The travel path is continuous, returning visitors to the lower level, as in a photovoltaic circuit. In terms of mining, the suggestion is an underground access ramp turned upside down; the journey becomes more solid and shaded as visitors ascend the ramp.

Functionally, the walkway and viewing platform are formed by a continuous low grade ramp that doubles back on itself, parallel to both the axes of the roadway and the east-west orientation of the arrays, which minimises overshadowing. Structural and textural expression suggests a local vernacular, incorporating elements of prominent Broken Hill mining structures as well as landmarks along the Barrier Highway. Materials are strong, durable and low maintenance, with low embodied energy.

BIOGRAPHY

/PLY/ is an architectural practice founded on the principle of a cohesive lamination of individual layers creating a single materialisation. /PLY/ was established in 2013, after the directors had been working for several years together at a large commercial architecture firm, forming a close working relationship based upon similar ideals and ethics. Our core philosophy is that the client is an integral part of the design process, creating a seamless bond between client and architect, architecture and the environment, architect and builder, architect and consultants, and the founders themselves. This has led to the manifestation that is now PLY, including the evolution of the name and brand.

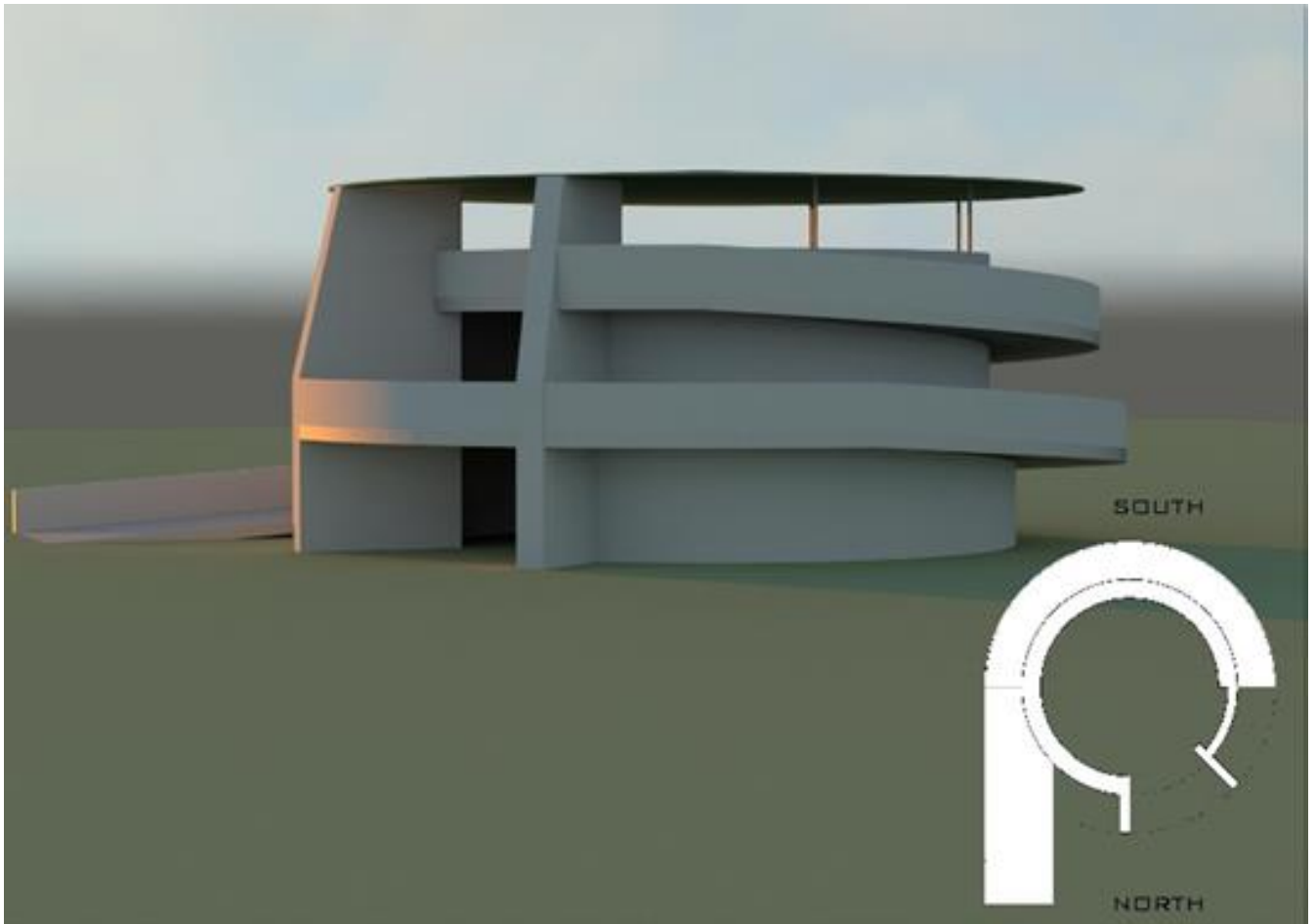

CONSTRUCTION MATERIALS: Primarily "green" concrete or at least concrete with a high recycled content. and Steel with a high recycled content.

DESCRIPTION: The design is influenced by American Mission 66 Architecture which was a National Park Architecture program leading up to the 50-year anniversary of National Parks in the States. It included great works like the Shark Valley observation tower in the Everglades. Now over 50 years old they have weathered well and still look great.

There are three levels to the structure - a ground level enclosed area, amid point level and the main viewing platform. This is because the building codes only allow a vertical rise of 3.6 m between levels via ramps - the middle level would also have viewing out towards the array. At ground level the enclosed circular space could include a water tank for catchment from the roof to water an easy care native shady garden.

BIOGRAPHY: Sam Vaughan is a building designer and draftsman from Broken Hill.



CONSTRUCTION MATERIALS: Steel or reinforced plastic would be the options to consider in the development of the sculpture at a larger scale. LED lights could be installed on the inside and outside DNA ribbons.

DESCRIPTION

In 1995 I asked myself “If all life is one in 4d then how is it one”? It’s taken a long time to be able to visually answer this question from the ultimate macrocosm of all life to the individual but now I can answer the question through my art. Everything in our three-dimensional world that lives or did live can be found in the four-dimensional world that we call the Tree of Life, it is a four-dimensional thumb print of Life on Earth. Calos Linnaeus designed a method of classifying life forms which in 1735 he published under the title of Systema Naturae (The System of Nature). His system of the classification of nature used eight taxa. I have created a ninth which goes further then species. My ninth level models heredity in 4d. In the four-dimensional world of the Tree of Life time is measured on a vertical axis.

My art visualises all living 4d bodies growing through time together as “tubes”. To have a child I modelled the DNA of both parents unwinding then a ribbon of DNA coming off each to form their child’s DNA. Then both parents and child’s DNA winding back up forming their 4d bodies which travel through time together. This is my artistic solution to the riddle of attachment within the Tree of Life in the microcosm. The Tree of Life is comprised of nothing but bodies in four dimensions attached via heredity. Out of the 5 kingdoms of life the animal kingdom is the kingdom

which has used electricity to achieve consciousness. I modelled the animal biomass of 600 million years. DNA Attachment is one detail in the sculpture I designed titled.

The Ninth Level which was made by jeweller Knut Mueller. The sculpture "the Ninth Level" could be installed underneath the viewing platform? The DNA Attachment motif is an intrinsic part of this sculpture. I can show sculpturally how the species in the ecosystem where the solar panels are located are scientifically connected to each other in the Tree of Life. I have designed a playground based on pathways through the Tree of Life

BIOGRAPHY: I make art about the ecology, geology and deep time history of natural environments. I have done over 25 artist residencies/projects about natural systems in Australia and abroad but it was during my first artist residency in 2006 at Broken Hill where I discovered my style. I met geologist Richard Plimer when I began my residency who explained the complex geology of Broken Hill. This gave me the idea of incorporating geological shapes into my art. I remember the night very clearly because the band mental as anything were playing out near the Desert Park and I was invited to go and see them.

But I had a feeling that I had to stay in the studio and that night I created Examining an Ancient Landscape at Broken Hill 01 which was a radical development in my style. Later in 2010 I was offered the position of artist for the Burke and Wills Environmental Expedition. The actor Jack Thompson was one of our patrons. On this project, I returned to Broken Hill and again it played an important role in my career. We were staying with Lindy and Simon Molesworth AO QC who were involved in trying to get Ramsar listing for the Menindee Lakes. I made a short film with Simon on the subject. I also made films with members from the Darling River Action Group and Geologist Barny Stevens.

I wanted people to be able to be able to access the films through my art but could not imagine how to do it. It was in a café on the main street of Broken Hill where I drew up my plans for an interactive website where people could learn about natural systems through interactive art. This website became SciArt which is now used in schools.

Although I have done many projects it was at Broken Hill that the concept for SciArt began: <http://sciart.com.au/projects/>.

In 2011 and 2013 I was involved in a project at Menindee Lakes collecting the plants which the botanist with Burke and Wills collected. In the last couple of years I have done artist residency projects at Naracoorte Caves, the Brisbane Ecosciences Precinct, El Nido (the Philippines), Alice Springs Desert Park and Uluru. At the moment, I am involved in a major Project titled "Following the Leeuwin Current" I started in the Kimberly and am now near Perth. I will follow the current to Tasmania along the coast. The project is a sequence of artist residencies.

Thus, far I have done residencies at Windjana Gorge, the Broome Bird Observatory, Cape Range National Park, Shark Bay and Mount Lesueur near the Nambung Pinnacle Desert. Through my career whilst creating art on natural systems I have been developing models for making visible how all aspects of the Tree of Life are one and what we look like. I have just finished writing a book on the subject and have many animations. My main discovery has been the modelling of four dimensional bodies and the means of attaching them via a DNA Attachment Motif.

> DESCRIPTION

> The top image shows a birds eye view of the platform. When observers focus on the internal view from our structure they will see elements of the past history and mining culture of Broken Hill as the levels and shape resemble the layers of a mine, these elements will be enhanced by flat lay rock artworks in the center of the ground floor. When gazing out to the solar installation viewers can observe and absorb the future of our mining culture - from mining the land to mining the sun.

The upper level of the platform resembles a boomerang in shape to give a sense of "return" to our land and community.

> The bottom left hand photo shows the positioning of our design in the proposed sight location.

> The bottom middle image shows the viewers perspective from the ground level entrance looking towards the platform and solar installation. The mirrors on the underside of the upper levels provide reflections of the platform and people on it. There will also be a mirror panel on the second level facing towards the solar installation to provide photo opportunities of the solar panels and the viewers reflection.

> The bottom right hand photo shows the sections of shade that the structure will provide at different times of the day. Additional options to provide further shelter and protection from the summer heat can be added to the existing design.

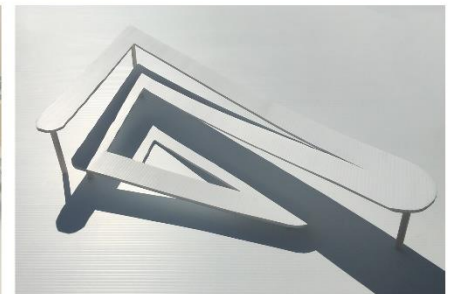
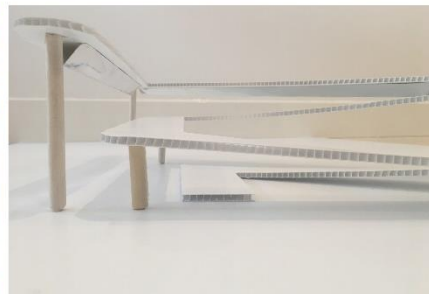

< 3 >

< 3 March 2017 | The Journey >

CONSTRUCTION MATERIALS

Materials that we have considered include corten/ weathering steel beams and mesh flooring resembling mining equipment, heritage sites and industrial eras of the community and City of Broken Hill. The corten steel blends in with the environment creating a connection with the earth and natural surroundings whilst withstanding the elements of extreme weather requiring minimal maintenance. Stainless steel cabling for deck and ramp fencing with timber hand rails.

Gabion walls can be used to create different levels, features, sculptures and artistic elements through landscaping around the platform and utilizing existing minerals and rocks sourced locally from Broken Hill.

Mirrored panels can be used to show reflections of the solar installation from multiple angles during the journey to the upper levels. This will be a great feature for people observing and taking photos from a different perspective enticing visitors to share their images over social platforms providing free marketing for our city and awareness of the solar installation. This material is also weather proof and durable making it easy to maintain for a long period of time. The mirrored panels also symbolize minerals local to Broken Hill. Solar LED lighting along the sides of the structure will be a feature that enhances the design at night, giving the platform perfect mood lighting for sunset viewings and functions

DESCRIPTION: Our platform design has been created to educate visitors and celebrate the history of the industrial foundation, culture and artistic flare of Broken Hill's community whilst giving insight and education on the renewable energy industry and sustainable thinking for future growth within the community and

environment (from mining the earth to mining the sun). The design has been created to take visitors on a journey from the minute they enter the platform. The gradual incline up the levels show the history of mining the ground and slowly working upwards to the bright future of mining the sun through educational plaques and stories on Broken Hill, the transition to solar energy and the benefits of the installation on the environment and future for Broken Hill and Australia moving forward into renewable energies. When viewing from the top-level visitors looking down internally will see the spiral design of the ramp resembling a mine with a centre art piece featuring historical minerals that helped shape what Broken Hill is today. This contribution reflects on the history of 130 years of mining in Broken Hill. The top viewing deck of the platform resembles the shape of a boomerang, acknowledging the history of the traditional landowners and like a boomerang does when you throw it "return" some love to the land and the community. The design of a triangular spiral ramp makes the platform universally accessible and provides panoramic views of the solar panels and the Pinnacles at multiple levels and viewing points.

BIOGRAPHY: Our group is made up of a creative collective of people with backgrounds in architecture, advertising and marketing, production and design and photography and filmmaking. With one member of the group local to Broken Hill and another having lived there in the past, our design was created through our experiences, relationships and memories of Broken Hill's history, culture and community.

101

JOURNEY OF THE SUN
SUSAN THOMAS



The journey of the Sun (glasshouse eco system)

From the Earth's perspective, the sun is constantly moving in a figure-of-eight pattern emulating the infinity symbol. This symbol refers to the idea of 'limitless potential' which I apply to the energy generated by the sun harvested at the AGL solar plant. The design could be envisaged in two ways: (1) to only consider the top above ground section of the design with a small surface dome containing a native garden and amenities situated below the seating area or (2) the full design including a subterranean underground area, with wall gardens and shallow reflective pools.

In either vision the space would be solar powered and harvest water runoff. Water would feed the gardens and be filtered for use throughout the building, creating an eco-system demonstrating the journey of the sun and its life-giving energy. On entering the building there is a ramp curving around a geodesic glass dome. At the top of the ramp is a sculpted seating area in the shape of the 'yin yang' symbol and the whole platform is encased in glass.

In the full vision (2), the notion of balance is infused with above and below ground areas. The Geodesic Subterranean Dome encapsulates the phrase "as above so below" and transforms the platform into a fully immersive environment. The dome is built with smart glass which switches from clear to a solid black providing a 360-degree surface for projections. The full vision aims to eventually equip the dome with surround sound as a space for events and installation art. Projections and installation artworks would focus on the subject of the Sun and stars. The space would be kept alive by a program of ongoing community activity involving interdisciplinary ecological fields, demonstrating the relationship between organisms and their environment (energy, biology, geography, and Earth science).



CONSTRUCTION MATERIALS

Adobe bricks made from dug out earth. Smart glass switching the dome from clear to black. Security glass with high UV block out over the platform and alongside ramps

DESCRIPTION: From the Earth's perspective, the sun is constantly moving in a figure-of-eight pattern emulating the infinity symbol. This symbol refers to the idea of 'limitless potential' which I apply to the energy generated by the sun harvested at the AGL solar plant. The design could be envisaged in two

ways: (1) to only consider the top above ground section of the design with a small surface dome containing a native garden and amenities situated below the seating area or (2) the full design including a subterranean underground area, with wall gardens and shallow reflective pools. In either vision the space would be solar powered and harvest water runoff. Water would feed the gardens and be filtered for use throughout the building; creating an eco-system demonstrating the journey of the sun and its life-giving energy. On entering the building there is a ramp curling around a geodesic glass dome. At the top of the ramp is a sculpted seating area in the shape of the 'yin yang' symbol and the whole platform is encased in glass.

In the full vision (2), the notion of balance is infused with above and below ground areas. The Geodesic Subterranean *Dome* encapsulates the phrase "as above so below" and transforms the platform into a fully immersive environment. The dome is built with smart glass which switches from clear to a solid black providing a 360-degree surface for *projections*. The full vision aims to eventually equip the dome with surround sound as a space for *events and installation art*. *Projections and installation artworks would focus on the subject of the Sun and stars. The space would be kept alive by a program of ongoing community activity involving interdisciplinary ecological fields, demonstrating the relationship between organisms and their environment (energy, biology, geography, and Earth science).*

BIOGRAPHY: I am an artist living in Broken Hill Far West NSW. I coordinate community programs and interested in environmentally focused art forms that utilise alternative energies. As well as art and new technologies my interest is in the public reception of art, whereby I am an advocate for the inclusion of art into everyday life; health and well-being, environmental practices and the development of new creative industries

102

**BROKEN HILL SOLAR FIELD
VIEWING PLATFORM
NICHOLAS GONSALVES**



AGL BROKEN HILL SOLAR FIELD VIEWING PAVILION

NICHOLAS GONSALVES

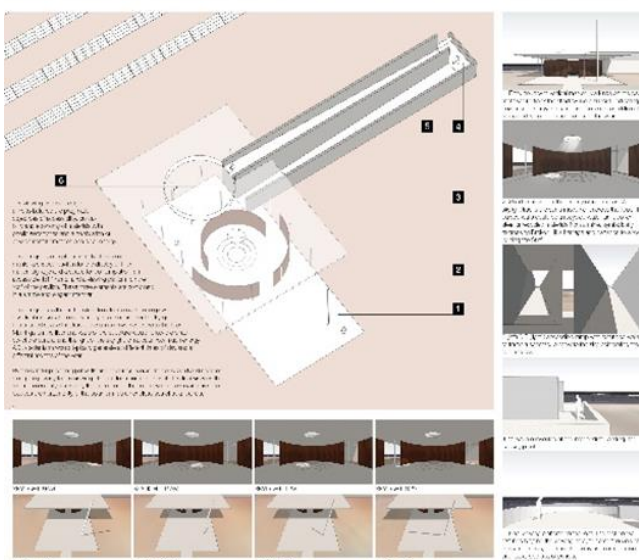

CONSTRUCTION MATERIALS: Concrete roof, concrete walls, concrete ramp and metal balustrade. Simple and economical materials to construct the majority of the structure. The round drum could be made from either a recycled water tank, corten steel or recycled materials from a mine, symbolically expressing Broken Hill's heritage and transition to a town 'Mining the Sun'. The vertical marker could similarly be built from a recycled steel beam or other element from a mine in order to express this transition.

DESCRIPTION

The viewing pavilion design aims to balance the pragmatic objectives of accessibility, buildability and economy of materials with poetic sensitivities and a celebration of environmental practices and solar energy. The design is a simple assembly of three elements; a shaded pavilion for the display of information signage and a space for contemplation; an accessible 1:14 ramp; and a viewing platform on the roof of the pavilion.

These three elements are combined in a simple and elegant manner. The design uses the architecture to celebrate solar energy with a vertical marker at the entry acting as a sundial, and a skylight in a shaded space that tracks the sun's movement across the floor. Markings on the floor and walls of the structure would follow the shadow of the sundial and the light of the skylight to indicate how much energy AGL's solar farm would typically generate at different times of day and at different months of the year. By the careful positioning of openings views are concealed and revealed along the journey to the viewing platform for maximum impact. The final view on the roof is horizontally framed by the projection of the roof beyond the viewing area, to express the horizontality of the solar farm s an endless sea of solar panels.

BIOGRAPHY: Nicholas Gonsalves is a registered architect practicing at Conrad Gargett Ancher Mortlock Woolley in Sydney. With an attitude towards design excellence, Nick approaches each project as a distinct opportunity to create a unique built outcome for each particular client, programme and context. Nick's ability for design has been recognised and awarded in national and international competitions. Nick achieved first place in 2013 and third place in 2016 in the UIA International Young Architect's Ideas Awards Design Competition. In 2013, Nick was an exhibited finalist in the international Lodge on the Lake Design Competition, and was key contributor in producing Conrad Gargett's design competition winning scheme for Somerset College's masterplan and new sporting facilities.

103

LIGHT WALKING
GIDEON BRAMWELLS & BRIONY EWING

CONSTRUCTION MATERIALS

Timber beams (stained in an iconic Australian blend of dark brown, walnut and dirty red) lodged in raised landscape. The structure has manifested itself around standard ramp conventions that allow for universal access.

DESCRIPTION

This project has been the result into a series of investigations exploring to symbolic and experiential qualities of light and sun. The objective of this proposal was to create a structure that could mimic the qualities of solar power. It acts firstly to internalise the sun, iconic of solar storage, behaving like light through a forest, shuttering erratically throughout the structure - flickering throughout the day. Its second act is to broadcast an artificial light between dusk and darkness, that externalises the solar storage from the day - artificial light bursting from within the structure. The structure both a landmark and a viewing experience.

BIOGRAPHY

Gideon Bramwells and Briony Ewing are recently graduated Architecture students from Monash university. Since having some time off between Masters, both of us want to start flexing our creative habits - starting to explore the opportunities such as architectural and arts competitions, as well as continuing to improve in painting and photography.

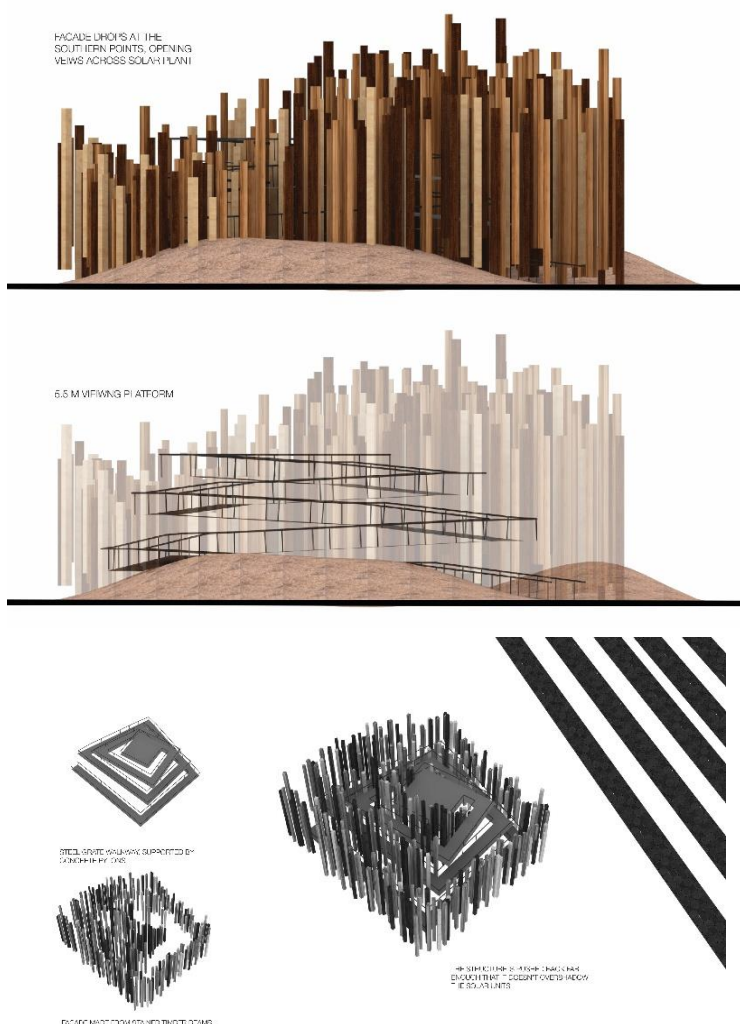

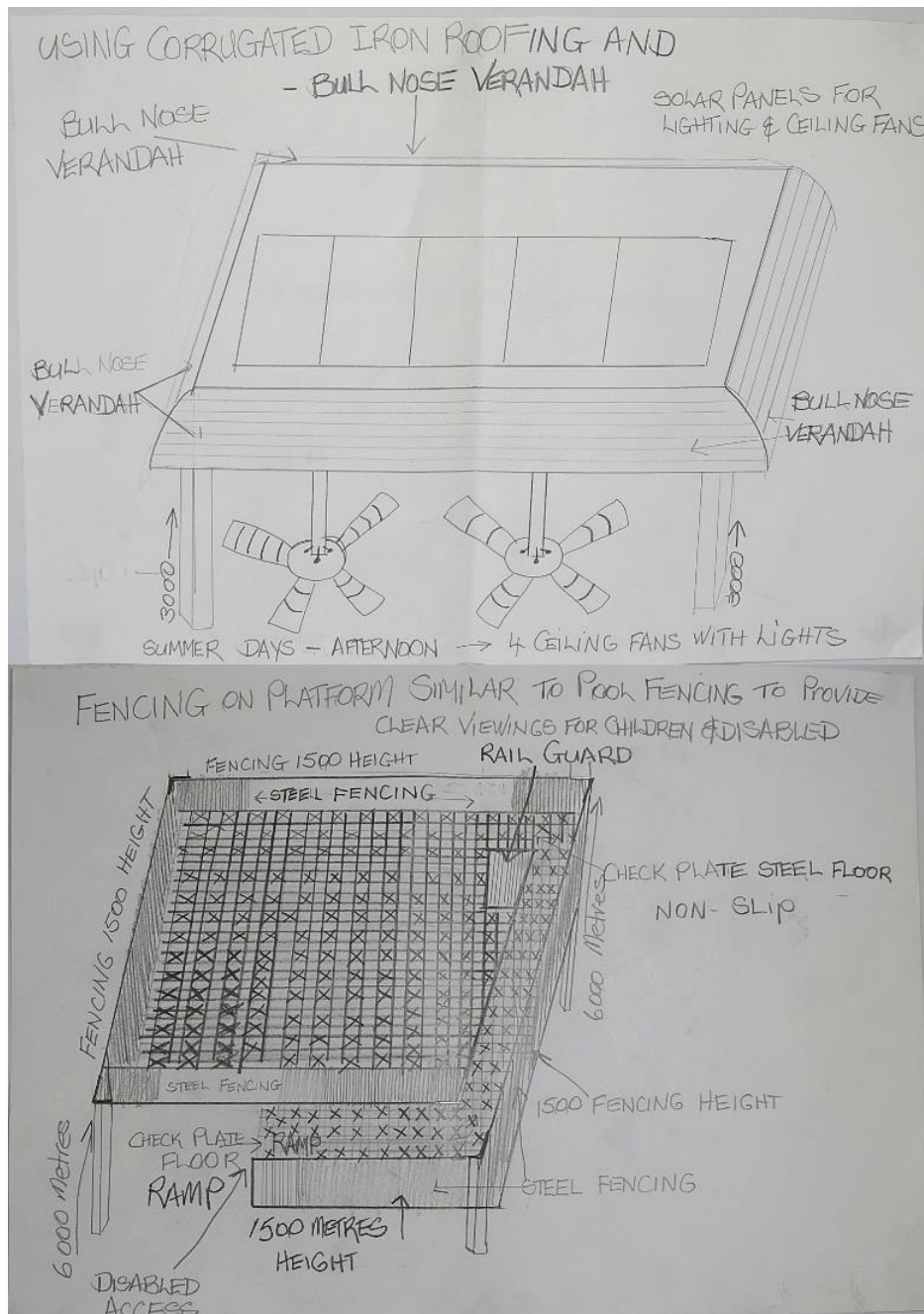

CONSTRUCTION MATERIALS: Zincalume fencing, chequered plate flooring. Posts, floor support all steel. Chosen steel for weather, maintenance, and strength.

I am interested in steelwork and design subjects at Willyama High School. (Broken Hill)

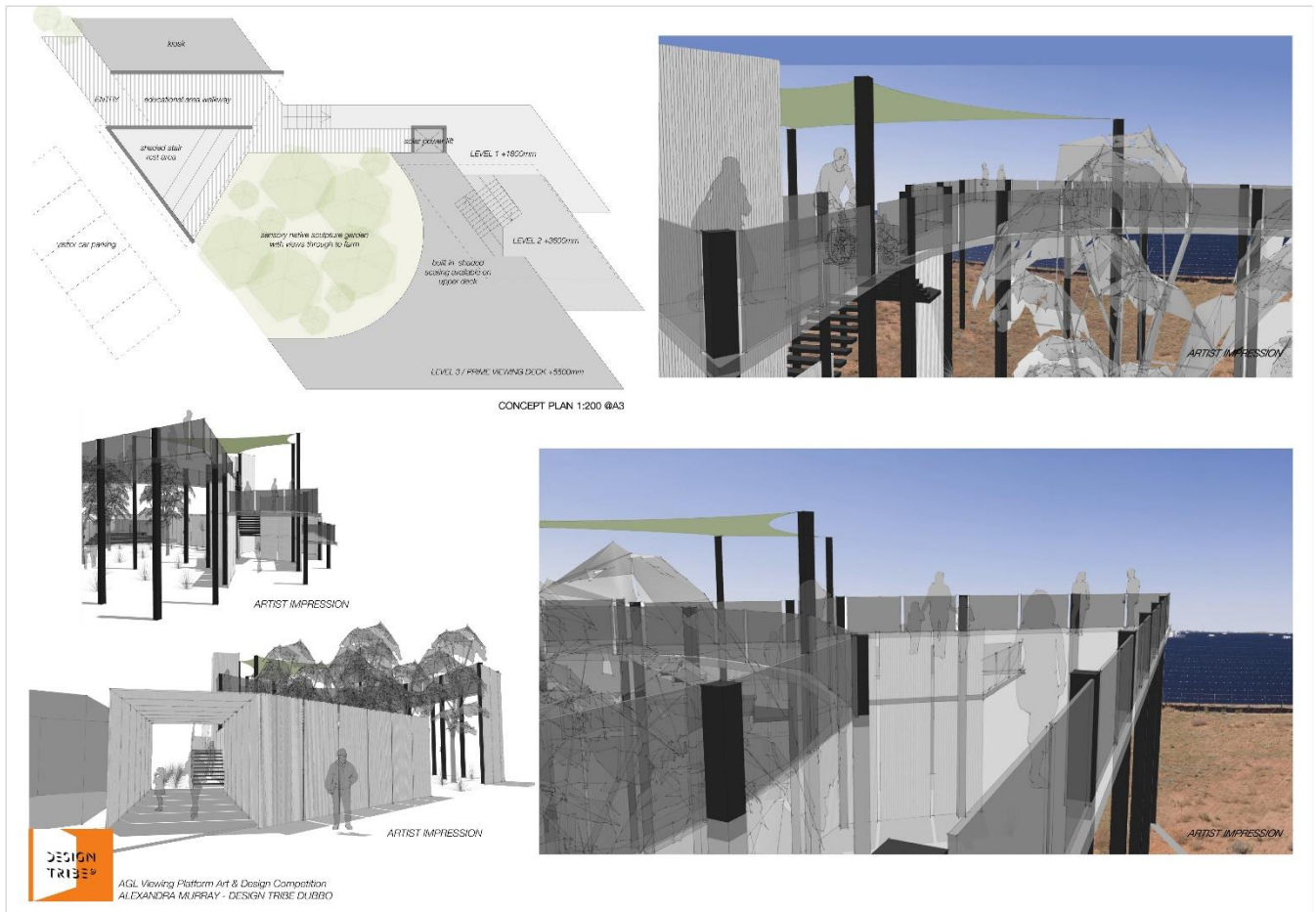

DESCRIPTION: My digital media entry is a very direct architectural response, proving a welcoming and sensory experience for visitors. I wanted to provide an education adventure, not just a single level walk-up design. The grid pattern of the solar field is very robust and rigid, and the form of the design takes on those angles. The 3 viewing levels terminate in the same acute angles to not only control the view but to guide visitors through the levels. The design also addresses the primary constraint of shadows, in order to confidently nestle closely into the grid and immerse the viewer fully into the solar field without jeopardising solar collection. The outlook from the car park deliberately presents as more solid and view restricting. However once you enter, the built form starts to peel back to create voids and filtered layers that control the user experience. Without leaving ground level, the educational composition provided, and the interstitial space created by the levels above (enhanced by a low water use garden filled with natives), provides a peaceful moment of pause in the shade to reflect on a presentation about the history of green power generation in Broken Hill. Then, the path taken to reach the top is very playful with steps, careful view reveals, directional changes and visual interest at all times until the final reveal up top that affords completely unobstructed views. I have done away with a disabled access ramp and instead propose a solar powered lift at ground level to transport visitors straight to the pinnacle!

CONSTRUCTION MATERIALS: I think the materials palette for this project is relatively simple. The town's history is intrinsically tied to mineral resources and that has heavily influenced my selections for this project, which primarily consist of steel and concrete. All are very raw and robust, and that sense of rawness signifies industry, progression and development, exactly what the AGL Solar Plant embodies. Softening down the core structure, the rest of the project shall be articulated with corrugated iron, laser cut steel and glass to compliment. Timber has always been in short supply in Broken Hill and as such shall not be used. Whilst a garden may be considered unnecessary, and water supply for the region has often been unsecured, plantings would considerably enhance the experience and

soften the very harsh build environment created by the solar field and viewing platform. It would be nice to show off some locally significant natives and endemic varieties such as Sturt's Desert Pea *swainsona formosa*, Turkey Bush *eremophila latrobei*, and Forked Twin Leaf *zygophyllum confluens* to name but a few low water species options.

Tied into the ground level to help create a sensory experience would be a sculpture garden curated by local groups. This may be under the control of the Wiljakali people, or the Broken Hill Art Exchange.

BIOGRAPHY: Design Tribe Dubbo was established in 2013 as a result of me (Alexandra Murray) wishing to move on from Sydney. Having grown up in Western NSW, Dubbo seemed like a good location to start my own Architecture practice that would service regional and remote NSW. I focus predominantly on the residential sector, however I have enjoyed working on everything from concept planning, residential, commercial and industrial. I have a passion for planning, passive design and the sustainable use of raw materials, and I would like to see architecture available to all, especially those in remote areas such as where I grew up.

www.designtribedubbo.com.au

www.facebook.com/designtribedubbo

Broken Hill Art Exchange wishes to acknowledge the Broken Hill City Council for its generous contribution in making the GeoCentre available as the competition's exhibition venue.





Founded in 2001, the Broken Hill Art Exchange Inc. is a non-profit organisation run by volunteers. The aim of is to support the progress of art and artists. We facilitate workshops and projects by visiting and local participants to create partnerships and linkages between the arts and other sectors (e.g. health, environment, education, industry and business).

The organisation's concept of exchange operates on multiple levels including the exchange of skills, knowledge and resources between different art practices, industries and communities.

BHAE Inc. welcomes interest from educational institutions wishing to establish campuses and conduct student field trips to the city. These initiatives present the opportunity for innovative research and development raising awareness about Broken Hill as Australia's first Heritage City. Its social, environmental, economic and cultural impact on nation building as well as its relevance to the post-industrial world are key focal drives of BHAE's international residency program.

BROKEN HILL ART EXCHANGE STAFF

The Broken Hill Art Exchange Incorporated is a not for profit volunteer based organisation

Project Team

Susan Thomas, Armando Licul, Bruce Green, James Naismith, Ricky, Georgie Watts, Ghislaine Barbe, Teresa Piastri, and Naomi Clogg

Employment and volunteer placements

Veronica Goodlett, Cheryl Ridge, Taylor Rose, Matt Chandler, Tiffany Pois & Shawn Brook

2016-17 BHAE Inc. Management Committee

President: Gary Cook

Artistic Director: Susan Thomas

Vice President: Bruce Green

Secretary & Public Officer: Ghislaine (Gigi) Barbe

Treasurer: Armando Licul

General members: James Naismith, Lesley Pippen

Special thanks to **Karyn Looby** AGL Manager Government and Community Relations
Thank you to all our sponsors and friends whose time and support is greatly appreciated.

To apply for the Broken Hill Art Exchange Residency Program or for information about the 2017 Desert Equinox Preludes (*Solar, Earth, Water and Air*) contact the Broken Hill Art Exchange at 08 8088 3171, email info@brokenhillartexchange.org.au

*Printed by T.Nicholls & Sons General Printers, 351 Blende Street Broken Hill Ph: 08 80873329
Email: admin@nichollsprinters.com.au*